

Combined Overcurrent and Earth Fault Relay



Features

- 3 stages phase overcurrent and earth fault
- IDMT and definite time
- Thermal overload protection
- Trip circuit supervision
- RS232 and RS485 MODBUS-RTU communication
- Fault, alarm and event records with timestamp
- Disturbance records
- Inrush blocking
- CB Maintenance
- Multi-shot autoreclose
- Negative sequence overcurrent
- Circuit breaker open/close control
- Programmable LED

Table of Contents

1.0 Introduction	3
1.1 Symbols and Definitions	3
1.2 Main Functions	4
2.0 Front Panel.....	5
2.1 LCD Display	5
2.2 Keypad	5
2.3 LEDs	6
2.4 RS232 Port.....	6
2.5 Default Display	6
2.6 Alarm Condition.....	6
2.6.1 Alarm Auto Scrolling	6
3.0 Password.....	7
3.1 Password Protection.....	7
3.2 Password Entry	7
3.3 Changing Password.....	7
4.0 Menus.....	7
4.1 Menu Contents	7
MEASUREMENTS Menu.....	9
RECORDS Menu.....	12
CONFIGURATION Menu.....	14
PROTECTION G1 Menu	17
PROTECTION G2 Menu	22
INPUT Menu.....	22
OUTPUT Menu.....	24
COMMUNICATION Menu.....	26
MISC CONTROL Menu.....	27
5.0 Functions and Descriptions	31
5.1 Circuit Breaker Failure Protection	31
5.2 Inrush Blocking.....	31
5.3 Thermal Overload Protection.....	32
5.4 Trip Circuit Supervision.....	33
5.5 Disturbance Recorder.....	35
5.6 Autoreclose	35
5.7 Open CB & Close CB Control.....	36
5.8 Characteristic Curves	37
6.0 Case Dimensions	39
7.0 Connection Diagram and Terminal	39
7.1 Terminal Connection at Rear View	39
7.2 Typical Connection Diagram	41
8.0 Technical Data.....	42
9.0 MODBUS Protocol.....	47
9.1 MODBUS Functions.....	47
9.2 MODBUS Register	49
9.3 MODBUS Mapping Format	57

1.0 Introduction

The purpose of this manual is to provide information necessary to install, operate and maintain the Mikro MK3000L relay.

MK3000L provides protections for 3 independent phase overcurrent elements and one non-directional earth-fault element. All these elements are connected to the current transformers of the feeders to be protected. There are 2 sets of current inputs, for 1A and 5A rated CTs.

The relay comes with liquid crystal display (LCD) with 2 x 16 back-lit alphanumeric characters and 7 LEDs in which 4 of the LEDs are programmable. An 8 button keypad can be used to access all measurements, alarm or trip records and settings. Dedicate Open CB (circuit breaker) and Close CB button is used to manually open and close CB.

There is a RS232 port available on the front panel and a RS485 port on the rear terminals. Using MODBUS RTU protocol, all stored information including alarm, trip and disturbance records can be read and settings can be modified with a PC loaded with setting software.

MK3000L has 4 configurable output relays. They can be activated by any of the protection functions available in the relay. There is also 1 output relay for internal fault indication. There are 2 configurable logic inputs for various functions.

1.1 Symbols and Definitions

In this manual and on the relay, unless the context otherwise requires, the following symbols and abbreviations shall apply throughout:-

AC	: Alternating current		
Ack	: Acknowledge	I2>>	: Negative sequence overcurrent second threshold
Alrm	: Alarm		
Aux	: Auxiliary	Invrse	: Inverse
CT	: Current transformer	Ip	: Input
CB	: Circuit breaker	IRF	: Internal Relay Failure
CBFP	: Circuit Breaker Failure Protection	LED	: Light emitting diodes
Chg	: Change	Lockd	: Locked
CLPU	: Cold Load Pickup	OC	: Overcurrent
DC	: Direct current	OL	: Overloaded
Dmd	: Demand	PU	: Pickup
Dmnd	: Demand	RCRD	: Record
DMT	: Definite time	Reclsr	: Recloser
EF	: Earth fault	Rmote	: Remote
E/Gnd	: Earth/Ground	Rst	: Reset
Genrl	: General	Strt	: Start
IDMT	: Inverse definite minimum time	TCS	: Trip circuit supervision
IL1	: Phase 1 current	Thml	: Thermal
IL2	: Phase 2 current	tI>	: Phase overcurrent first threshold trip
IL3	: Phase 3 current	tI>>	: Phase overcurrent second threshold trip
I>	: Phase overcurrent first threshold	tI>>>	: Phase overcurrent third threshold trip
I>>	: Phase overcurrent second threshold	tIo>	: Earth fault first threshold trip
I>>>	: Phase overcurrent third threshold	tIo>>	: Earth fault second threshold trip
Io/IN	: Earth (fault) current	tIo>>>	: Earth fault third threshold trip
Io>	: Earth fault first threshold	tI2>	: Negative sequence overcurrent first threshold trip
Io>>	: Earth fault second threshold		
Io>>>	: Earth fault third threshold	tI2>>	: Negative sequence overcurrent second threshold trip
I2>	: Negative sequence overcurrent first		

1.2 Main Functions

The following table shows the functions available for MK3000L

ANSI codes	Features
50P/51P	Three-phase overcurrent
50N/51N	Earth fault overcurrent
49RMS	Thermal overload (True RMS)
46N	Negative sequence overcurrent
	Cold load pickup
	Instantaneous/start contact
86	Latching output contacts
	Setting groups
50BF	Circuit breaker failure detection
74TC	Trip circuit supervision
94/69	Circuit breaker monitoring and control
68	Blocking logic
	Inrush blocking
	Auxiliary timers
79	Multi-shot autoreclose
	Test of output relays (maintenance)
	CB control local/remote

General Features	
Number of digital inputs	2
Number of outputs relays	5
Events recording	250
Fault recording	50
Alarms	30
Disturbance recording	6*
Setting group	2
Auxiliary timers	2
Communication ports	Front RS232, Rear RS485
Communication	Modbus RTU
Time synchronization	Via communication port, via digital input
Measurements	Currents values & frequency, max and average currents values

* Disturbance recording options: 6 x 3s, 4 x 4s, 3 x 5s, 2 x 7s, 1 x 9s

2.0 Front Panel

Using the front panel, the user can easily navigate through the user friendly menu, read measurements and change settings. The relay status and alarm or trip records are displayed on the back-lit LCD also.



MK3000L Front panel

2.1 LCD Display

The LCD has 2 lines with 16 characters each. Back light is on when a key is pressed and remain on for predefined time duration. The brightness can be adjusted to suit the lighting conditions.

2.2 Keypad

There are 8 keys on the front panel.

Up, Down, Enter and Esc are used to navigate through the menus and adjust the settings.



Up : Scroll up the menus or increase setting value.



Down : Scroll down the menus or decrease setting value.



Esc : To exit from menus, submenus or to cancel setting value change. Press and hold for 1.5 seconds to return to default display from any submenu.



Enter : To enter submenus or to confirm setting value change.



Clear : To reset tripping, reset latched relay. If “CLEAR” Scroll is enabled (under Configurations-> Display menu) and during no alarm status, it can be used to scroll through Phase Overcurrent and Earth Fault settings, and to return to default display from any submenu if pressed and hold for 1.5 seconds.



Record : To display Alarm records. To display successive records, press Record key again.



Open CB : To open circuit breaker from front panel.



Close CB : To close circuit breaker from front panel.

2.3 LEDs

- Aux LED : Indicates auxiliary power to the device
- Trip LED : Indicates tripping.
- Alarm LED : Blinks to indicate non acknowledge alarm (or tripping). Steady on when the alarm is acknowledged by pressing any key
- Programmable LED : 4 Programmable LED can be programmed to turn on when one or more linked function trigger.

2.4 RS232 Port

The front panel RS232 port has the same MODBUS RTU protocol as the RS485 port on the rear terminal, though with fixed communication settings: 38400bps, 1 stop bit, even parity, address 1.

All stored information can be read and settings can be modified with a PC loaded with the supplied setting software.

2.5 Default Display

By default the LCD displays the current value measured for IL1, IL2, IL3 and Io. Input and output status as well as date and time can be shown by pressing Up key or Down key to change the default display page. Pressing Esc key always return to current value display.

As soon as an alarm or trip is detected, the display jumps to alarm record display to show the latest record.

2.6 Alarm Condition

During an alarm or tripping condition, Alarm LED blinks. Alarm record pops up. Any keypress change the Alarm LED to steady on.

tl> trip	1 / 2
L2	500A

Example of Alarm record title page, showing record 1 out of total 2 records. Press Enter to enter sub page for this record. Press Record/Down to show next alarm. Press Up to show previous alarm. Press Esc to return to Default Display. Press Clear to clear the alarm. If the condition still persists, the alarm cannot be cleared.

Date:	03/02/2015
Time:	08:23:44am

Alarm record sub page, showing record date and time. Press Esc/Enter/RECORD to return to Alarm Record title page.

Clear all alarm?
Clear= CLEAR

Clearing all record menu is shown when Up is pressed during display of Record 1's title page, or RECORD/Down is pressed during display of Last records title page. Press Clear to clear all Alarm record or Esc to cancel.

2.6.1 Alarm Auto Scrolling

10 seconds after alarm record pops up, the Alarm display will be auto scrolled to show sub page and

subsequently next records until all the records are shown and repeats. Each page is shown for 5 seconds. Example when there are 2 alarm records:

Record 1 Title Page → Record 1 Sub Page → Record 2 Title Page → Record 2 Sub Page → Record 1 Title Page →

Any key pressed stops auto scrolling. After 2 minutes of no activity, with which display still showing the alarm record, auto scrolling starts again.

3.0 Password

3.1 Password Protection

Relay settings can be view anytime but locked from being changed. A password is required for changing setting and CB Open, CB Close button pressed.

The password consists of four digit numbers. The factory default password is set as 0000.

The programming mode is indicated with the letter "P" on the right hand side of the display. The letter "P" remains present as long as the password is active. (2 minutes if there is no key action).

3.2 Password Entry

The input of the password is requested as soon as a modification of a parameter is made or Open/Close CB button is pressed. The user enters each one of the 4 digits by using up or down key and validates each digit with Enter. If Esc is pressed in between, the password entering is terminated.

“Password OK” is shown if correct password is entered. “Password ERROR” is shown if wrong password is entered.

The display returns to the point of the preceding menu. Pressed Enter again to modify the setting.

If no key is pressed after 2 minutes, the settings are locked. A new password request is associated with any subsequent setting change.

3.3 Changing Password

To change the password, go to Op Parameter -> Password menu. Enter current password to unlock, after that the display shows current password. Press Enter again to enter the new password.

4.0 Menus

The menu is divided into 9 main menus and their corresponding submenus. To enter Main menu, press Enter during default display.

The menu can be navigated by pressing Up, Down, Enter and Esc keys. There is no need of a password when reading settings and measured values.

4.1 Menu Contents

The Main menu consists of 9 items. The menu structure is shown below:

Main Display and Menu Contents

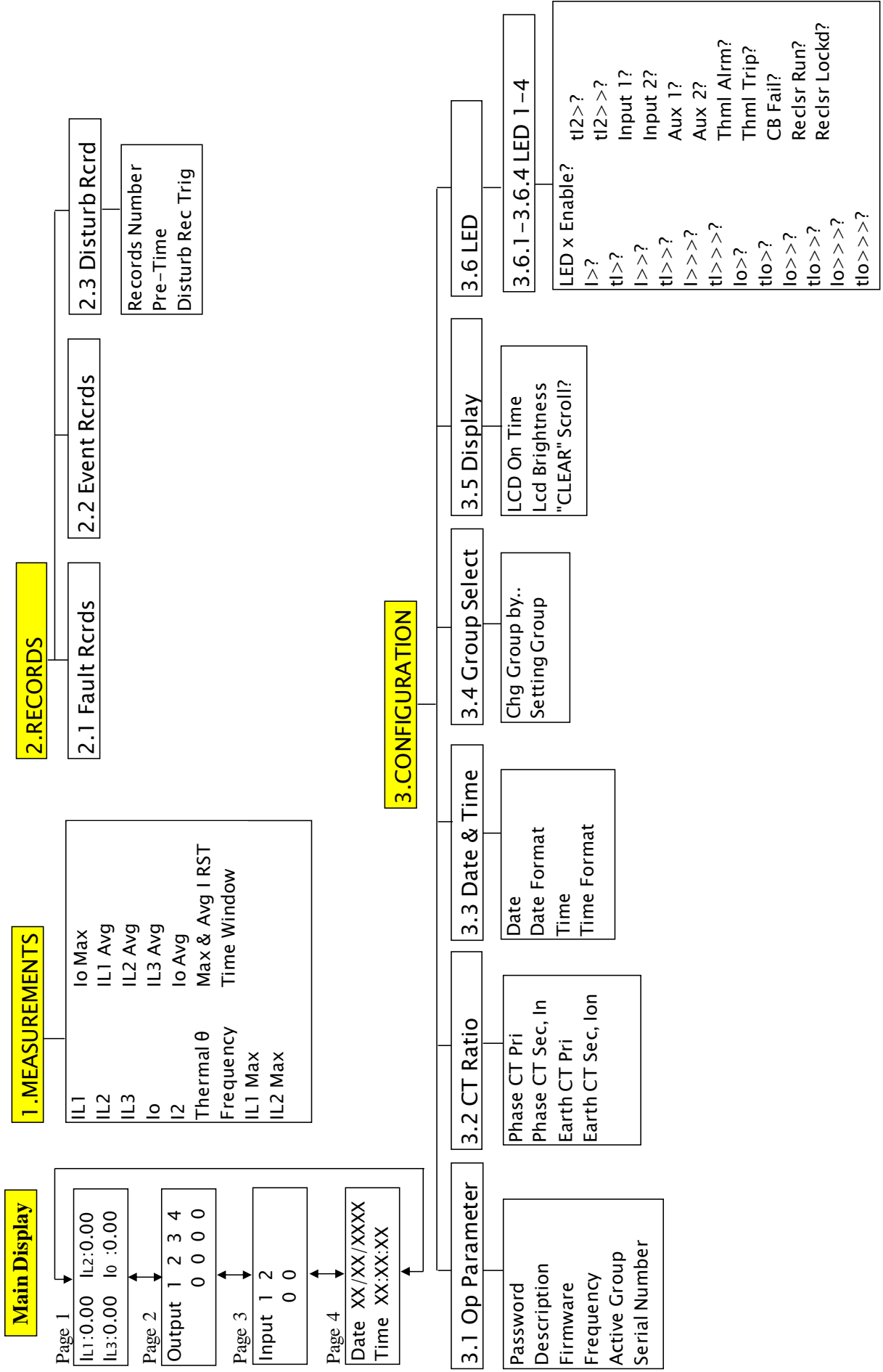

Main Display

Page 1	IL1:0.00 IL2:0.00 IL3:0.00 Io :0.00
Page 2	Output 1 2 3 4 0 0 0 0
Page 3	Input 1 2 0 0
Page 4	Date XX/XX/XXXX Time XX:XX:XX

1. MEASUREMENTS

IL1	Io Max
IL2	IL1 Avg
IL3	IL2 Avg
Io	IL3 Avg
I2	Io Avg
Thermal θ	Max & Avg I RST
Frequency	Time Window
IL1 Max	
IL2 Max	

2. RECORDS

2.1 Fault Rcrds	2.2 Event Rcrds	2.3 Disturb Rcrd
		Records Number Pre-Time Disturb Rec Trig

3. CONFIGURATION

3.1 Op Parameter	3.2 CT Ratio	3.3 Date & Time	3.4 Group Select	3.5 Display	3.6 LED
Password Description Firmware Frequency Active Group Serial Number	Phase CT Pri Phase CT Sec, In Earth CT Pri Earth CT Sec, Ion	Date Date Format Time Time Format	Chg Group by.. Setting Group	LCD On Time Lcd Brightness "CLEAR" Scroll?	3.6.1-3.6.4 LED 1-4 LED x Enable? l1>? tl1>? l2>? tl2>? Input 1? Input 2? Aux 1? Aux 2? Thrm1 Alrm? Thrm1 Trip? CB Fail? Reclsr Run? Reclsr Lockd?

4.PROTECTION G1

5.PROTECTION G2

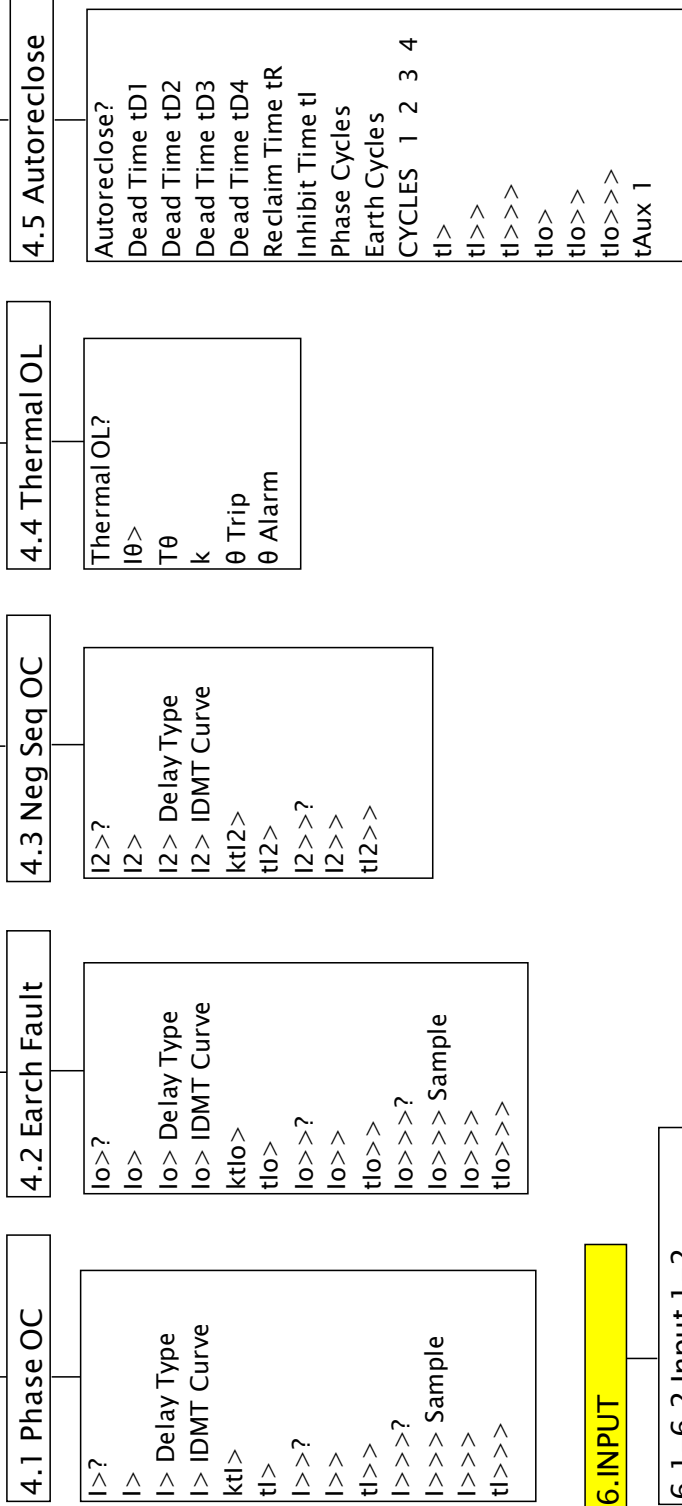

Similar to PROTECTION G1

6.INPUT

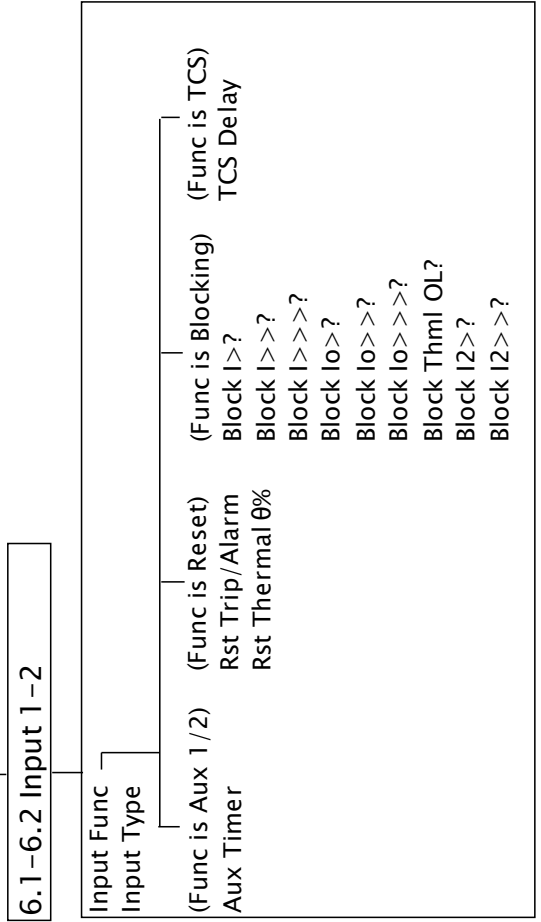

9. MISC CONTROL

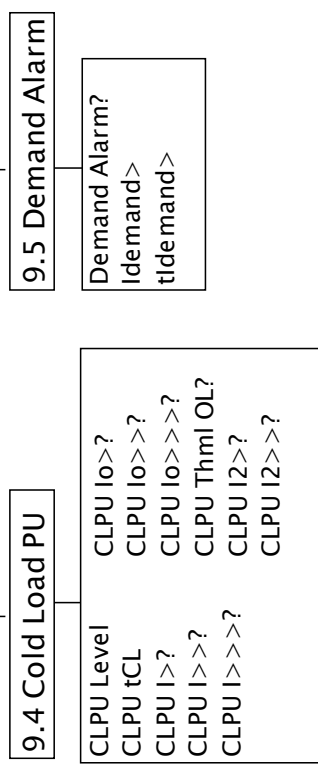
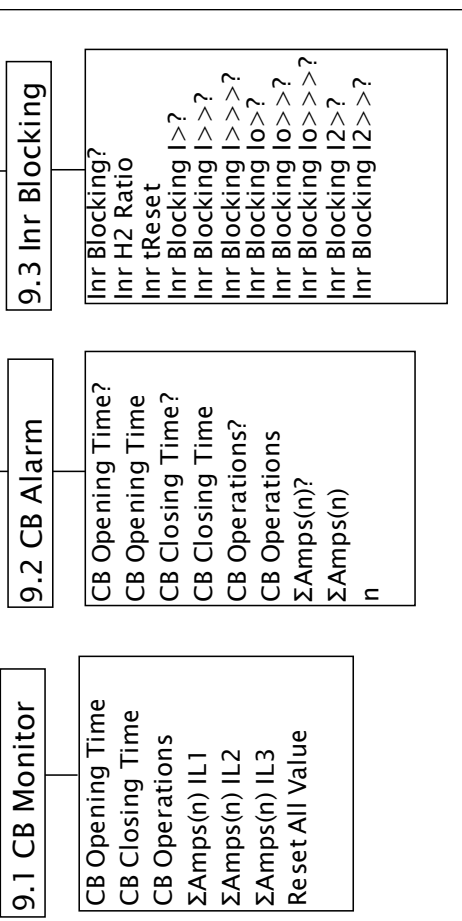

7. OUTPUT

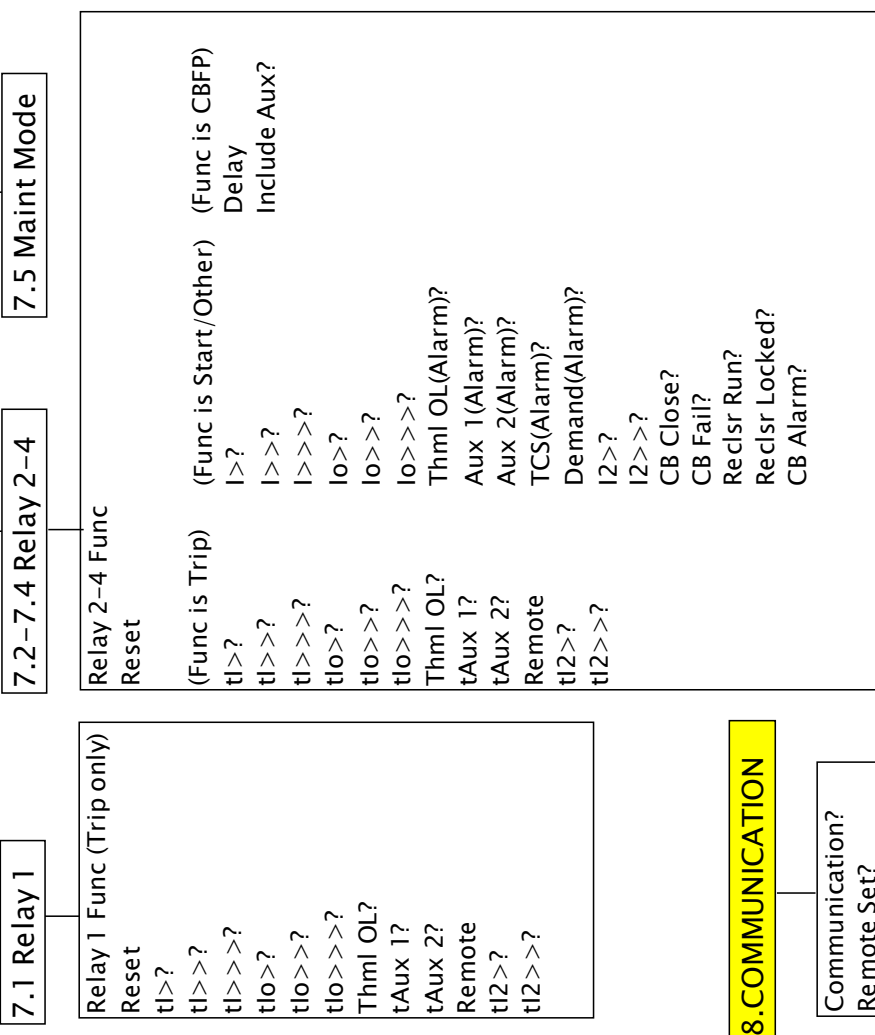

8. COMMUNICATION

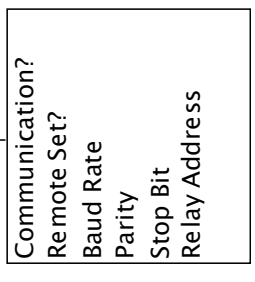

MEASUREMENTS Menu

Various measurement values can be read under MEASUREMENTS menu. (The values are shown for illustrative purpose).

1.MEASUREMENTS	Heading of MEASUREMENTS menu. Press Enter to enter submenu content.
IL1 52.0A	Displays phase 1 current value. Taking into account of Phase CT Pri ratio.
IL2 88.2A	Displays phase 2 current value. Taking into account of Phase CT Pri ratio.
IL3 64.2A	Displays phase 3 current value. Taking into account of Phase CT Pri ratio.
Io 4.23A	Displays earth current value. Taking into account of E/Gnd CT Pri ratio.
I2 4.23A	Displays negative sequence value. Taking into account of Phase CT Pri ratio.
Thermal θ RST=CLEAR	Displays thermal % state. Calculated on true RMS current values. Press Clear to clear the % values.
Frequency 50.01Hz	Displays current frequency calculated from phase 1 currents.
IL1 Max 120A	Displays peak phase 1 current value.
IL2 Max 234A	Displays peak phase 2 current value.
IL3 Max 1.23kA	Displays peak phase 3 current value.
Io Max 1.23kA	Displays peak earth current value.

IL1 Avg
323A

Displays average phase 1 current value.

IL2 Avg
80.4A

Displays average phase 2 current value.

IL3 Avg
78.2A

Displays average phase 3 current value.

Io Avg
6.24A

Displays average earth current value.

Max & Avg I RST
RST= CLEAR

To clear the maximum and average values of the currents. Press Clear to clear these values.

Time Window
10min

Set the value for the time window (rolling) during which maximum and average values are stored. Press Enter to change the value.

RECORDS Menu

2.RECORDS

Heading of RECORDS menu. Press Enter to enter submenu content.

Fault Records Menu

2.1 Fault Rcrds

Heading of Fault Record submenu. Press Enter to enter submenu content.

tl> trip [1]
L3 15.2A

Example of Fault Record title page, showing trip element, source, value and record number 1. Press Up or Down to show another record of Enter to enter sub page for this record. Press Clear to clear this record.

Date: 03/01/2016
Time: 10:19:52am

Fault record sub page 1, showing record date and time. Press down to show next sub page. Press Esc/Enter to return to Fault Record title page.

Active Set Group
1

Fault record sub page 2, showing active protection setting group during fault. Press Up/down to change sub page. Press Esc/Enter to return to Fault Record title page.

IL1 Magnitude 4.86A	Fault record sub page 3, showing L1 current during fault. Press Up/down to change sub page. Press Esc/Enter to return to Fault Record title page.
IL2 Magnitude 4.52A	Fault record sub page 4, showing L2 current during fault. Press Up/down to change sub page. Press Esc/Enter to return to Fault Record title page.
IL3 Magnitude 15.2A	Fault record sub page 5, showing L3 current during fault. Press Up/down to change sub page. Press Esc/Enter to return to Fault Record title page.
Io Magnitude 1.2A	Fault record sub page 6, showing Io current during fault. Press Up to previous sub page. Press Esc/Enter to return to Fault Record title page.

Event Records Menu

2.2 Event Rcrds	Heading of Event Record submenu. Press Enter to enter submenu content.
Genrl strt [1]	Example of Event title page. Press Enter to enter sub page for this record.
Date: 03/02/2011 Time: 08:23:44am	Event record sub page, showing record date and time. Press Esc/Enter to return to Fault Record title page.

Disturbance Records Menu

2.3 Disturb Rcrd	Heading of Disturbance Record submenu. Press Enter to enter submenu content.
Records Number 6 Rec x 3 sec	Set the disturbance record length and number. Press Enter to change between None (disable), 6 Rec x 3 sec, 4 Rec x 4 sec, 3 Rec x 5 sec, 2 Rec x 7 sec and 1 Rec x 9 sec.



Note: Changing the record length and number will cause existing records being deleted. If necessary, read all wanted records before making changes.

Pre-Time 0.1s	Set the disturbance record pre-time. Step 0.1s.
Disturb Rec Trig ON INST	Criteria which will start the disturbance record function. Setting choices are ON INST (starts recording on start/instantaneous thresholds) or ON TRIP (starts recording on a tripping).

CONFIGURATION Menu

3.CONFIGURATION

Heading of CONFIGURATION menu. Press Enter to enter submenu content.

Op parameter Menu

3.1 Op Parameter

Heading of Op Parameter submenu. Press Enter to enter submenu content.

Password

This password is required when changing relay settings. Press Enter to enter a new password. The user needs to enter existing password to unlock, after that the display shows current password. Press Enter again to enter the new password.

Description

MK3000L

Model name of this relay

Firmware

1.0

Version of the firmware.

Frequency

50Hz

Set the nominal value of the line frequency. Press Enter to change this value.

Active Group

50Hz

Currently active protection group.

CT Ratio Menu

3.2 CT Ratio

Heading of CT Ratio menu. Press Enter to enter submenu content

Phase CT Pri

500A

Set the rated primary current of the Phase/Line CT.

Phase CT Sec, In

5A

Set the rated secondary current of the Phase CT according to the CT input terminal used. This setting affects disturbance record current scaling only.

Earth CT Pri

200A

Set the rated primary current of the Earth/Ground CT.

Earth CT Sec, In

1A

Set the rated secondary current of the Earth/Ground Phase CT according to the CT input terminal used. This setting affects

disturbance record current scaling only.

Note: The CT secondary should be connected to 5A or 1A CT input terminal according to the CT secondary current rating. The display current is calculated by the formula:

$$\text{Current at CT input terminal} / \text{CT input terminal type} \times \text{CT Pri (setting above)}$$

For example:

Current at CT input terminal = 3A, CT input terminal type = 5A, CT Pri = 200A, The display value = $3/5 \times 200 = 120\text{A}$	Current at CT input terminal = 3A, CT input terminal type = 1A, CT Pri = 100A, The display value = $3/1 \times 100 = 300\text{A}$
--	--

Date & Time Menu

3.3 Date & Time	Heading of Date & Time menu. Press Enter to enter submenu content.
Date 18/01/2016	Displays the date. Press Enter to change the date.
Date Format DD/MM/YYYY	Set the date format for display. Press Enter to change between DD/MM/YYYY, MM/DD/YYYY.
Time 10:46:23am	Displays the time. Press Enter to change the time, starts from hour, minute and am/pm (if 12 hour format is selected). Second will be reset to 0 when enter is pressed for any of the digit.
Time Format 12-hour	Set the time format. Press enter to change between 12 and 24 hour.

Group Select Menu

3.4 Group Select	Heading of Group Select menu. Press Enter to enter submenu content.
Chg Group by... Menu	Set whether the protection group setting is change by Menu or Input. One of the input function must be set to 'Select Group' if Input is selected. Press Enter to change.
Setting Group 1	If above is set to Menu, this will set the active protection group. Press Enter to change.

Display Menu

3.5 Display	Heading of Display menu. Press Enter to enter submenu content.
-------------	--

LCD On Time 10min	Set how long the LCD backlight remains on after no key is pressed. Press Enter to change.
----------------------	---

LCD Brightness Medium	Set the brightness of the LCD backlight. Press Enter to change.
--------------------------	---

"CLEAR" Scroll? No	Set if Clear key can be used (during no alarm or trip state) to scroll through the default display pages, Phase OC and Earth OC settings (for currently selected group), as well as to return to Default Display from Record display. This is useful when Up, Down, Enter and Esc key is inaccessible due to the front panel is covered and locked.
-----------------------	---

LED Menu

LED4 to LED 7 configuration is used to assign a protection function to a LED output. The LED lights up when the protection function is active. For tI>, tI>>, tI>>>, tIo>, tIo>>, tIo>>>, tI2> and tI2>> trip, the LED is latched by its respective alarm record, LED is off when its alarm record is cleared.

3.6 LED	Heading of LED Menu. Press Enter to enter submenu content
---------	---

LED 4 to LED 7 menu has similar content. The LED 4 menu content is shown below:

3.6.1 LED 4	Heading of LED 4 Menu. Press Enter to enter submenu content.
-------------	--

LED 4 Enable? Yes	Enable or disable LED 4 operation. If yes is selected, the following menu is shown:
----------------------	--

I>? Yes	Assigned I> start to LED
------------	--------------------------

tI>? Yes	Assigned tI> trip to LED
-------------	--------------------------

I>>? Yes	Assigned I>> start to LED
-------------	---------------------------

tI>>? Yes	Assigned tI>> trip to LED
--------------	---------------------------

I>>>? Yes	Assigned I>>> start to LED
--------------	----------------------------

tI>>>? Yes	Assigned tI>>> trip to LED
---------------	----------------------------

Io>? Yes	Assigned Io> start to LED
-------------	---------------------------

tIo>? Yes	Assigned tIo> trip to LED
--------------	---------------------------

Io>>?	Yes	Assigned Io>> start to LED
tIo>>?	Yes	Assigned tIo>> trip to LED
Io>>>?	Yes	Assigned Io>>> start to LED
tIo>>>?	Yes	Assigned tIo>>> trip to LED
tI2>?	Yes	Assigned I2> start to LED
tI2>>?	Yes	Assigned tI2> trip to LED
Input 1?	Yes	Assigned Input 1 status to LED
Input 2?	Yes	Assigned Input 2 status to LED
Aux 1?	Yes	Assigned Aux1 Alarm/trip to LED
Aux 2?	Yes	Assigned Aux2 Alarm/trip to LED
Thml Alm?	Yes	Assigned thermal alarm to LED
Thml Trip?	Yes	Assigned thermal trip to LED
CB Fail?	Yes	Assigned CB fail to LED
Reclsr Run?	Yes	Assigned recloser running to LED
Reclsr Lockd?	Yes	Assigned recloser locked to LED
TCS Alm?	Yes	Assigned TCS alarm to LED

PROTECTION G1 Menu

4.PROTECTION G1	Heading of PROTECTION G1 (Group 1) menu. Press Enter to enter submenu content.
-----------------	--

Phase OC Menu

4.1 Phase OC	Heading of Phase OC (Overcurrent) menu. Press Enter to enter submenu content.
--------------	---

I> menu

I>?	Yes	Set to Yes to enable phase overcurrent first threshold (I>). Then the following menu is displayed.
-----	-----	--

I>	2.00In	Set the value for the current threshold I>. NOTE : When delay type is IDMT, the maximum setting recommended should be 2.00In.
----	--------	---

I> Delay Type	IDMT	Set the time delay type of I>. Setting choices are: IDMT (inverse definite time curve) and Definite Time.
---------------	------	---

If Definite Time is selected, the following menu is displayed:

tl> 1.00s	Set the value for the time delay of I> definite time.
------------------	---

If IDMT is selected, the following menu is displayed:

I> IDMT Curve Normal Invrse	Set the type of curve.
--------------------------------	------------------------

ktl> 0.20	Set the time multiplier setting value for the curve.
------------------	--

I>> menu

I>>? Yes	Set to Yes to enable phase overcurrent second threshold (I>>). Then the following menu is displayed.
-----------------	--

I>> 9.00In	Set the value for the current threshold I>>.
-------------------	--

tl>> 100ms	Set the value for the time delay of I>> definite time.
-------------------	--

I>>> menu

I>>>? Yes	Set to Yes to enable phase overcurrent third threshold (I>>>). Then the following menu is displayed.
------------------	--

I>>> Sample Yes	Set to yes to enable I>>> operated on current sample base. Otherwise it operates on fundamental value. Sample base method will ensure fast tripping on highly saturated current signal.
--------------------	---

I>>> 20.0In	Set the value for the current threshold I>>>.
--------------------	---

tl>>> 30ms	Set the value for the time delay of I>>> definite time.
-------------------	---

Earth Fault Menu

4.2 Earth Fault	Heading of Earth Fault menu. Press Enter to enter submenu content.
-----------------	--

Io> menu

Io>? Yes	Set to Yes to enable earth fault first threshold (Io>). Then the following menu is displayed.
-------------	---

Io> 0.10Ion	Set the value for the current threshold Io>. NOTE : When delay type is IDMT, the maximum setting recommended should be 0.5Ion..
----------------	--

Io> Delay Type IDMT	Set the time delay type of Io>. Setting choices are: IDMT and Definite Time.
------------------------	--

If Definite Time is selected, the following menu is displayed:

tIo> 1.00s	Set the value for the time delay of Io> definite time.
---------------	--

If IDMT is selected, the following menu is displayed:

Io> IDMT Curve Normal Invrse	Set the type of curve.
---------------------------------	------------------------

ktIo> 0.20	Set the time multiplier setting value for the curve.
---------------	--

Io>> menu

Io>>? Yes	Set to Yes to earth fault second threshold (Io>>). Then the following menu is displayed.
--------------	--

Io>> 1.00Ion	Set the value for the current threshold Io>>.
-----------------	---

tIo>> 100ms	Set the value for the time delay of Io>> definite time.
----------------	---

Io>>> menu

Io>>>? Yes	Set to Yes to enable earth fault third threshold (Io>>>). Then the following menu is displayed.
---------------	---

Io>>> Sample Yes	Set to yes to enable Io>>> operated on current sample base. Otherwise it operates on fundamental value. Sample base method will ensure fast tripping on highly saturated current signal.
---------------------	--

Io>>>
20.0In

Set the value for the current threshold Io>>>.

tIo>>>
30ms

Set the value for the time delay of Io>>> definite time.

Neg Seq OC

4.3 Neg Seq OC

Heading of Neg Seq OC (Negative Sequence Overcurrent) menu.
Press Enter to enter submenu content.

I2> menu

I2>?
Yes

Set to Yes to enable negative overcurrent first threshold (I2>). Then the following menu is displayed.

I2>
0.10In

Set the value for the current threshold I2>.
NOTE : When delay type is IDMT, the maximum setting recommended should be 0.5In..

I2> Delay Type
IDMT

Set the time delay type of I2>. Setting choices are: IDMT and Definite Time.

If Definite Time is selected, the following menu is displayed:

tI2>
1.00s

Set the value for the time delay of I2> definite time.

If IDMT is selected, the following menu is displayed:

I2> IDMT Curve
Normal Invrse

Set the type of curve.

ktI2>
0.20

Set the time multiplier setting value for the curve.

I2>> menu

I2>>?
Yes

Set to Yes to earth fault second threshold (I2>>). Then the following menu is displayed.

I2>>
1.00In

Set the value for the current threshold I2>>.

tl2>> 100ms

Set the value for the time delay of I2>> definite time.

Thermal OL Menu

4.4 Thermal OL

Heading of Thermal OL (Overload) menu. Press Enter to enter submenu content.

Thermal OL? Yes

Set to Yes to enable thermal overload protection. Then the following menu is displayed.

I θ > 1.50In

Set the value for the thermal overload I θ >.

T θ > 10min

Set the value for the thermal time constant.

k> 1.10

Set the value for the k factor.

θ Trip 100%

Set the percentage of the thermal overload trip.

θ Alarm 100%

Set the percentage of the thermal overload alarm.
(To disable this alarm, set this value to equal or higher than θ Trip %)

Autoreclose Menu

Refer to 5.5 *Autoreclose* for more detail explanation.

4.5 Autoreclose

Heading of autoreclose menu. Press Enter to enter submenu content.

Autoreclose? Yes

Set to Yes to enable autoreclose function. Then the following menu is displayed.

Dead Time tD1 2.00s

Set the dead time for reclose cycle 1. The dead time starts when the CB has opened (52A input deactivates) and the involved protection threshold reset

Dead Time tD2 3.00s

Set the dead time for reclose cycle 2.

Dead Time	
tD3	6.00s

Set the dead time for reclose cycle 3.

Dead Time	
tD4	10.00s

Set the dead time for reclose cycle 4.

Reclaim Time	
tR	8.00s

Set the reclaim time. . The reclaim time starts when the CB has closed (52A input activates). If no tripping after reclaim time elapsed, the autoreclose resets.

Inhibit Time	
tl	20.0s

Set the inhibit time. This timer is used to block the autoreclose being initiated after lockout and CB is manually closed onto a fault.

Phase Cycles	
	3

Set the number of shots for phase cycle. Applies to tI>, tI>>, tI>>>, tAux 1 and tAux 2

Earth Cycles	
	2

Set the number of shots for earth fault. Applies to tIo>, tIo>> and tIo>>>

CYCLES	1	2	3	4
tl>	0	1	1	1
tl>>	1	1	1	1
tl>>>	1	1	2	1
tlo>	1	1	1	1
tlo>>	0	1	1	1
tlo>>>	1	1	1	2
tAux 1	0	0	1	1
tAux 2	0	0	1	1

Set the actions to be executed for each cycle associated to the trip or start for each element.

0: Recloser will move to lock status after tripping.
 1: Tripping, followed by reclose cycle.
 2: No trip or pickup.

PROTECTION G2 Menu

5.PROTECTION G2 (Group 2) menu has similar content as PROTECTION G1 (Group 1) menu. The Protection G2 settings are applied when Protection Group 2 is activated.

INPUT Menu

6.INPUT

Heading of INPUT menu. Press Enter to enter submenu content.

6.1 Input 1

Heading of Input 1 menu. Press Enter to enter submenu content.

Input 1 Func
Aux 1

Set the function of Input 1. Setting choices are: None, Aux 1, Aux 2, Reset, Blocking, TCS, Select Group, Cold Load PU (pickup) and Sync Clock, CB Status 52A, Blk Autoreclose, Control Close, Start Dist Rcrd, Local

Aux 1 or Aux 2: The input is used as auxiliary alarm or tripping signal.

If tAux is not assigned to trip output relay (whether it is assigned to a start output relay or not), activation of the input will generate an Aux Alarm signal after time delay.

If tAux is assigned to trip output relay, the input will generate an Aux Trip signal after time delay.

Reset, Blocking, TCS: See below

Select Group: Input deactivates to select Protection Group 1, activates to select Protection Group 2. To enable changing group by input, 3.4 Group Select->Chg Group by.. must be set to Input.

Cold Load PU: Activation of the input starts CLPU timer and increases protection threshold defined by 3.7 Cold Load PU setting.

Sync Clock: Activation of the input will set the clock to the nearest minute.

CB Status 52A: Position of Circuit breaker. Activate: CB close, deactivate: CB open. Required for CB monitoring and autoreclose.

Blk Autoreclose: Blocking of the autoreclose function

Control Close: Activation of the input to assert a manual CB close. One of the output relay function must be CB close for this to function.

Start Dist Rcrd: Start disturbance recording.

Local Mode: Disable setting changed by communication and remote command to Relay

An input is activated by level or edge depending on its function:

On level:	Aux 1, Aux 2, Blocking, TCS, Select Group, CB Status 52A, Blk Autoreclose, Local Mode
On Edge:	Reset, Cold Load PU, Sync Clock, Control Close, Start Dist Rcrd

Input 1 Type
Active High

Set how the input 1 is activated. For Active High, energizing the input activates the input. For Active Low, de-energizing the input activates the input.

If Aux 1 or Aux 2 is selected, the following menu is displayed:

Aux timer 500ms

Set the value for the time delay of Aux 1 or 2 definite time.

If Reset is selected, the following menu is displayed:

Rst Trip/Alarm	Yes	Set to yes to enable the input to reset trip and alarm.
Rst Thermal 0%	Yes	Set to yes to enable the input to reset thermal %.

If Blocking is selected, the following menu is displayed:

Block I>?	Yes	Set to yes to enable blocking of I>
Block I>>?	Yes	Set to yes to enable blocking of I>>
Block I>>>?	Yes	Set to yes to enable blocking of I>>>
Block Io>?	Yes	Set to yes to enable blocking of Io>
Block Io>>?	Yes	Set to yes to enable blocking of Io>>
Block Io>>>?	Yes	Set to yes to enable blocking of Io>>>
Block Thml OL?	Yes	Set to yes to enable blocking of Thermal Overload
Block I2>?	Yes	Set to yes to enable blocking of I2>
Block I2>>?	Yes	Set to yes to enable blocking of I2>>

If TCS (trip circuit supervision) is selected, the following menu is displayed:

Aux timer	500ms	Set the value for the time delay of TCS. TCS alarm triggers when the input is deactivated for longer than the time delay. TCS function is enabled when the trip output relay R1 is not energized.
-----------	-------	---

Input 2 Menu has similar content as Input 1 menu. The settings are applied to input 2.

OUTPUT Menu

7.OUTPUT	Heading of OUTPUT menu. Press Enter to enter submenu content.
----------	---

Output Relay 1

7.1 Relay 1	Heading of output relay 1 menu. Press Enter to enter submenu content.
-------------	---

Relay 1 Func	Trip	Set the function of output Relay 1. Note that Relay 1 function is locked to Trip.
Reset	Auto	Set the reset method of relay: Auto (Unlatched), Manual (Latched).
tl>?	Yes	Assign I> trip to the output relay.
tl>>?	Yes	Assign I>> trip to the output relay.

tl>>>?	Yes	Assign I>>> trip to the output relay.
tlo>?	Yes	Assign Io> trip to the output relay.
tlo>>?	Yes	Assign Io>> trip to the output relay.
tlo>>>?	Yes	Assign Io>>> trip to the output relay.
Thml OL?	Yes	Assign Thermal Overload to the output relay.
tAux 1?	Yes	Assign Aux 1 input trip to the output relay.
tAux 2?	Yes	Assign Aux 2 input trip to the output relay.
Remote	Yes	Assign Remote trip (by communication and Open CB control) to the output relay
tl2>?	Yes	Assign I2> trip to the output relay.
tl2>>?	Yes	Assign I2>> trip to the output relay.

Output Relay 2 to 4

Output Relay 2 to 4 menu has similar content. The output Relay 2 menu content is shown below:.

7.2 Relay 2	Heading of output Relay 2 menu. Press Enter to enter submenu content.	
Relay 2 Func	Trip	Set the function of output Relay 2. Possible settings are: Trip, Start/Other and CBFP .
Reset	Auto	Set the reset method of relay: Auto (Unlatched), Manual (Latched).

If relay function is set to Trip, the menu content similar to Relay 1 is shown, please refer to Output Relay 1.

If relay function is set to Start/Other, the following menu is displayed:

I>?	Yes	Assign I> start to the output relay.
I>>?	Yes	Assign I>> start to the output relay.
I>>>?	Yes	Assign I>>> start to the output relay.
Io>?	Yes	Assign Io> start to the output relay.
Io>>?	Yes	Assign Io>> start to the output relay.
Io>>>?	Yes	Assign Io>>> start to the output relay.
Thml OL(Alarm)?	Yes	Assign Thermal Overload Alarm to the output relay.

tAux 1(Alarm)?	Yes	Assign Aux 1 input alarm to the output relay.
tAux 2(Alarm)?	Yes	Assign Aux 2 input alarm to the output relay.
TCS(Alarm)?	Yes	Assign TCS alarm to the output relay.
Demand(Alarm)?	Yes	Assign Demand alarm to the output relay.
I2>?	Yes	Assign I2> alarm to the output relay.
I2>>?	Yes	Assign I2>> alarm to the output relay.
CB Close?	Yes	Assign CB Close signal to the output relay.
CB Fail?	Yes	Assign CB Fail alarm to the output relay.
Reclsr Run?	Yes	Assign Recloser run alarm to the output relay.
Reclsr Locked?	Yes	Assign Recloser locked alarm to the output relay.
CB Alarm?	Yes	Assign CB Alarm to the output relay.

If relay function is set to **CBFP** (Circuit Breaker Failure Protection) the following menu is displayed:

Delay 200ms	Set the value for the time delay of CBFP. This output relay is activated, if after the activation of the trip relay, the fault has not been cleared for longer than this delay.
Include Aux? No	Set if Aux 1 or 2 input is included as fault condition. Prolonged activation or latched Aux input could cause the undesirable activation of CBFP relay.

Maintenance Mode Menu

7.5 Maint mode (Prot disabled)	Heading of Maintenance Mode menu. Press Enter to enter submenu content.
Output 1 2 3 4 Test 0 0 0 0	Press Enter once, output 1 blinks, press Up/Down to toggle the output status. Press Enter again to test output 2, and subsequently for output 3 and 4. Press Esc to exit.

COMMUNICATION Menu

Communication setting is applicable to the RS485 port on the rear terminals of the relay (the front panel RS232 port has fixed communication settings: 38400bps, 1 stop bit, even parity, address 1).

8.COMMUNICATION	Heading of COMMUNICATION menu. Press Enter to enter submenu content.
-----------------	--

Communication? Yes	Set to yes to enable MODBUS RTU communication.
Remote Set? Yes	Set to yes to enable setting change through communication. When set to no, only Reset alarm/trip, Reset maximum and average measurement value, Reset display, and change of date and time is allowed.
Baud Rate 38400bps	Set the baud rate in bit per second (bps).
Parity Even	Set the parity in the data frame.
Stop Bit 1	Set the number of stop bit in the data frame.
Relay Address 1	Set the address of the relay in the MODBUS network.

MISC CONTROL Menu

9.MISC CONTROL	Heading of Miscellaneous Control) menu. Press Enter to enter submenu content.
----------------	---

CB Monitor

Through CB Monitor and CB Alarm menu, it is possible to read and clear counter values (CB Monitoring) and assigned alarm (CB Alarm) related to circuit breaker. Most of the CB Monitor functions are only available when one of the input functions is CB status 52A.

9.1 CB Monitor	Heading of CB Monitoring menu. Press Enter to enter submenu content.
CB Opening Time 90ms	Displays circuit breaker opening time. Measured between the activation of trip output relay and the deactivation of 52A input.
CB Closing Time 110ms	Displays circuit breaker closing time. Measured between the activation of CB close output relay and the activation of 52A input.
CB Operations 76	Displays the number of operations of the circuit breaker

Σ Amps(n) IL1 345 kA	Displays the summation of the current (in Amps or square Amps, set by 'n' in CB Alarm menu) for phase 1 interrupted by the circuit breaker.
--------------------------------	---

Σ Amps(n) IL2 12 kA	Same as above for phase 2
-------------------------------	---------------------------

Σ Amps(n) IL3 1.2 MA	Same as above for phase 3
--------------------------------	---------------------------

Reset All Value RST=CLEAR	Reset all the counter value in CB Monitor menu,
------------------------------	---

CB Alarm

9.2 CB Alarm	Heading of CB Alarm menu. Press Enter to enter submenu content.
--------------	---

CB Opening Time? Yes	Set to Yes to enable circuit breaker opening alarm. The following menu is displayed.
-------------------------	--

CB Opening Time 150ms	Set the value for the circuit breaker opening time threshold.
--------------------------	---

CB Closing Time? Yes	Set to Yes to enable circuit breaker closing alarm. The following menu is displayed.
-------------------------	--

CB Closing Time 250ms	Set the value for the circuit breaker closing time threshold.
--------------------------	---

CB Operations? Yes	Set to Yes to enable circuit breaker operations alarm. The following menu is displayed.
-----------------------	---

CB Operations 200	Set the value for the circuit breaker operations threshold.
----------------------	---

Σ Amps(n)? Yes	Set to Yes to enable the summation of the current (in Amps or square Amps) alarm.
--------------------------	---

Σ Amps (n)	100MA
-------------------	-------

Set the summation of the current (in Amps or square Amps) threshold.

n	1
---	---

Set the exponent for the summation for Σ Amps. 1 (IA) or 2 (I^2A^2)

Inr Blocking

9.3 Inr Blocking

Heading of Inrush Blocking menu. Press Enter to enter submenu content

Inr Blocking?	Yes
---------------	-----

Set to Yes to enable the crossing of the 2nd Harmonic ratio threshold on any phase activates the Inrush Blocking Logic function instantaneously.

Inr H2 Ratio	20%
--------------	-----

Set the value for the 2nd harmonic threshold ratio.

Inr tReset	100ms
------------	-------

Set the value for the Inrush tReset time. This provides a reset delay of the Inrush Blocking once the 2nd harmonic level falls below the set threshold

The following protection functions can be assigned for inrush blocking.

Inr Blocking I>?	Yes
------------------	-----

Enable or disable inrush blocking for I>

Inr Blocking I>>?	Yes
-------------------	-----

Enable or disable inrush blocking for I>>

Inr Blocking I>>>?	Yes
--------------------	-----

Enable or disable inrush blocking for I>>>

Inr Blocking Io>?	Yes
-------------------	-----

Enable or disable inrush blocking for Io>

Inr Blocking Io>>?	Yes
--------------------	-----

Enable or disable inrush blocking for Io>>

Inr Blocking Io>>>?	Yes
---------------------	-----

Enable or disable inrush blocking for Io>>>

Inr Blocking I2>?	Yes
-------------------	-----

Enable or disable inrush blocking for I2>

Inr Blocking I2>>?	Yes
--------------------	-----

Enable or disable inrush blocking for I2>>

Cold Load Pickup Menu

Cold Load Pickup allows selected settings to be altered to respond to temporary overload conditions that may occur during cold starts. These conditions could be switching on large heating load after a extended cooling period, air conditioning, or inductive loads that draw high starting current like motor.

To enable cold load pickup, one of the input functions has to be set to Cold Load PU.

9.4 Cold Load PU

Heading of Cold Load Pickup menu. Press Enter to enter submenu content.

CLPU Level 200%

Scaling value, in percent, for the cold load pick up assigned to the selected thresholds.

CLPU tCL 5.00s

Delay timer setting (tCL) for the Cold Load Pickup function.

The following protection functions can be assigned to cold load PU.

CLPU I>?	Yes
----------	-----

Assign I> with the cold load pick up function.

CLPU I>>?	Yes
-----------	-----

Assign I>> with the cold load pick up function.

CLPU I>>>?	Yes
------------	-----

Assign I>>> with the cold load pick up function.

CLPU Io>?	Yes
-----------	-----

Assign Io> with the cold load pick up function.

CLPU Io>>?	Yes
------------	-----

Assign Io>> with the cold load pick up function.

CLPU Io>>>?	Yes
-------------	-----

Assign Io>>> with the cold load pick up function.

CLPU Thml OL?	Yes
---------------	-----

Assign Thermal Overload (I θ >) with the cold load pick up function.

CLPU I2>?	Yes
-----------	-----

Assign I2> with the cold load pick up function.

CLPU I2>>?	Yes
------------	-----

Assign I2>> with the cold load pick up function.

Demand Alarm Menu

Demand alarm is used to give alarm signal when load current is higher than the threshold. The threshold is set lower than overcurrent for proper functioning.

9.5 Demand Alarm

Heading of Demand Alarm menu. Press Enter to enter submenu content.

Demand Alarm? Yes

Set to Yes to enable demand alarm. Then the following menu is displayed.

Idemand> 1.50In

Set the value for the current threshold Idemand>.

tIdemand> 9.00s

Set the value for the time delay of Idemand>.

5.0 Functions and Descriptions

5.1 Circuit Breaker Failure Protection

Circuit breaker failure protection (CBFP) is used to generate a tripping signal via selected output relay after a preset time delay if the fault has not been cleared after the activation of tripping signal through trip contact relay R1. Thermal overload is excluded from fault condition for CBFP.

CBFP output is usually used to trip the upstream circuit breaker or to trip a redundant tripping circuit of the same circuit breaker.

CBFP function can be assigned to relay R2 to R4.

There is an option to enable or disable Aux 1 or 2 as a fault condition (if Aux 1 or 2 is assigned to a digital input as a tripping source). Prolonged activation or latched Aux input could cause the undesirable activation of CBFP relay, in this case set 'Include Aux' to 'No' to disable the condition.

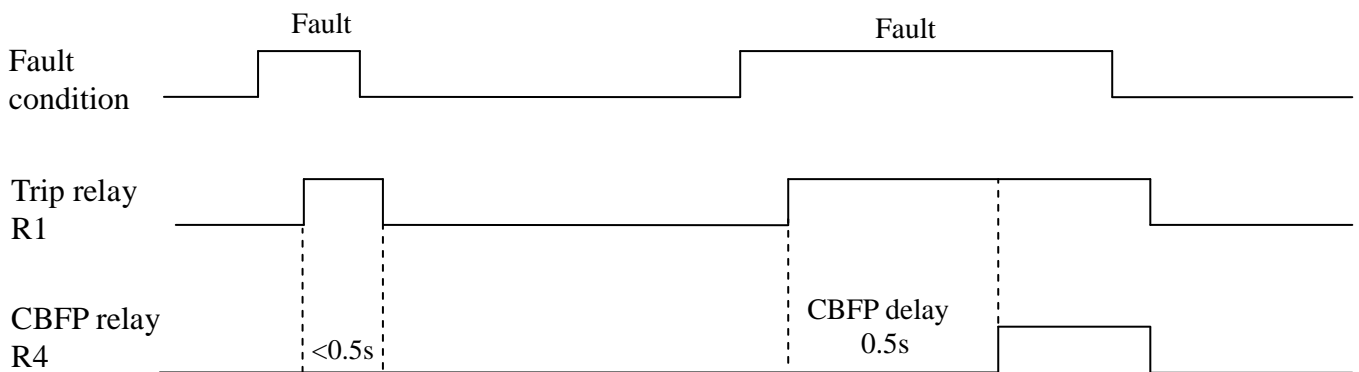

Timing diagram for CBFP. (R4 function set to CBFP, delay 0.5s.)

5.2 Inrush Blocking

The inrush blocking function can be used to block the overcurrent (selectable: $I>$, $I>>$, $I>>>$), earth fault ($I_o>$, $I_o>>$, $I_o>>>$) and negative sequence overcurrent ($I_2>$, $I_2>>$) starting due to inrush current with second harmonic component. During transformer energization, the second harmonic component of the inrush current is high. The relay activates inrush blocking for any phase with second harmonic current ratio above the Inr H2 Ratio. In general, a setting of 15 to 20% can be applied. A too high setting may result in the overcurrent tripping during transformer energization. A too low setting may prevent tripping during some internal transformer faults with significant second harmonic current. $0.2I_n$ minimum fundamental current is required for operation of inrush blocking function.

The reset delay (t_{Reset}) of the Inrush Blocking once the 2nd harmonic level falls below the set threshold can be set depends on the transient inrush duration. Typically from 0.1seconds (for 100kVA transformer) to 1.0 second (for a large transformer)

5.3 Thermal Overload Protection

Thermal overload protection can be used to prevent damages to the equipment of the electrical plant. A prolonged overloading causes excessive heating, which may result in deterioration of the insulation, or in extreme cases, insulation failure.

Load current is used to calculate the heating and cooling effect of the equipment to be protected. The highest phase current is automatically used as input information for the thermal model. The thermal overload protection can be set with both alarm and trip stages, θ Trip % and θ Alarm %, with 5% below the set % for resetting.

The heating within any plant equipment, such as cables or transformers, is of resistive type ($I^2R \times t$). Thus the thermal time characteristic used in the relay is based on current squared, integrated over time.

Protection equipment is designed to operate continuously at a temperature corresponding to its full load rating, where heat generated is balanced with heat dissipated. Over-temperature conditions occur when currents in excess of rating flow for a certain period of time. It can be shown that temperatures during heating follow exponential time constants and a similar exponential decrease of temperature occurs during cooling.

In order to apply this protection element, the thermal time constant (T_{θ}) of the plant equipment to be protected is therefore required.

The calculation of the Time to trip is given by:

$$T_{\text{trip}} = T_{\theta} \ln \left(\frac{K^2 - \theta}{K^2 - \theta_{\text{trip}}} \right)$$

Valid when:
 $K^2 > \theta$
 $K^2 > \theta_{\text{trip}}$

T_{trip} = Time to trip (in seconds)

T_{θ} = Thermal time constant of the protected element (in seconds)

K = $\frac{I_{\text{eq}}}{k.I_{\theta >}}$

I_{eq} = Equivalent current corresponding to the RMS value of the largest phase current.

$I_{\theta >}$ = Full load current rating given by the national standard or by the supplier.

k = Factor associated to the thermal state formula.

θ = Initial thermal state. If the initial thermal state = 30% then $\theta = 0.3$

θ_{trip} = Trip thermal state. If the trip thermal state is set at 100%, then $\theta_{\text{trip}} = 1$

The settings of these parameters are available in the menus:

PROTECTION G1/G2 – Thermal OL

The calculation of the thermal state is given by the following formula:

$$\theta_{\tau+1} = K^2 (1 - e^{-\frac{\tau}{T_{\theta}}}) + \theta_{\tau} e^{-\frac{\tau}{T_{\theta}}}$$

θ being calculated every 20ms.

5.4 Trip Circuit Supervision

Trip Circuit Supervision (TCS) enables the trip circuit to be monitor. To enable TCS function, set one of the Digital Input function to TCS (at the INPUT Menu), Input Type as Active High and set the appropriate TCS delay time.

The continuity of trip circuit is monitor when Trip contact R1 is not energized. When the input detects no signal for a time longer than the TCS delay time, TCS alarm pops up to warn the failure of trip circuit. Three examples of application are given below.

Example 1: Trip Coil Monitoring

In this example only 52a auxiliary contact is available; the trip coil is monitored when the CB is open or closed.

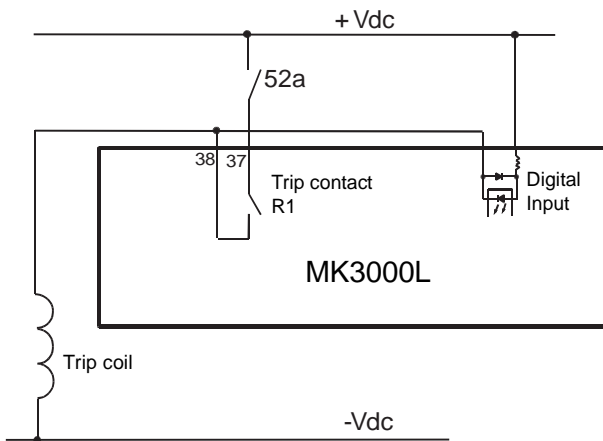

Example 2: Trip Coil and Auxiliary Contacts Monitoring

In this example both 52a and 52b auxiliary contacts are available. The complete trip circuit is monitored when the CB is closed and a part of the trip circuit when the CB is open (excluding Trip coil).

It is necessary to insert resistor R1 in series with 52b, if the Trip contact R1 is latched or it stays involuntarily closed.

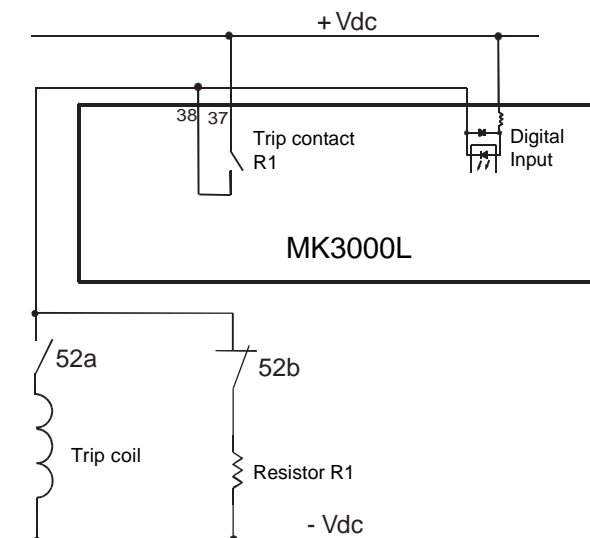

Examples 3: Trip Coil and Auxiliary Contacts Monitoring when CB is open or closed

In this example both 52a and 52b auxiliary contacts are available; the complete trip circuit is monitored when the CB is open or closed.

In this case it is necessary to insert resistor R1, if the Trip contact R1 is latched or it stays involuntarily closed.

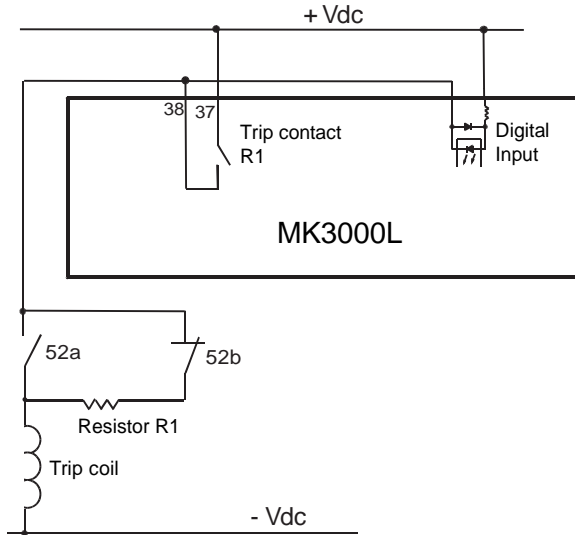

Recommended Resistor R1 Value

The recommended maximum resistor R1 value for various auxiliary voltage is shown:

Auxiliary Voltage, Ua	24Vdc	36Vdc	48Vdc	60Vdc	72Vdc	110Vdc	132Vdc
Maximum R1 value (Ohm)	4.7k	9.1k	13k	16k	22k	43k	62k
Power rating (W)	1/4	1/4	1/2	1/2	1/2	1	1

Auxiliary Voltage, Ua	220Vdc	264Vdc
Maximum R1 value (Ohm)	82k	91k
Power rating (W)	2	2

For the case of example 3, the maximum R1 value should be deducted by Trip coil resistance (insignificant in most cases).

The Power rating of the resistor R1 is calculated as:

$$P_{R1} > 2 \times \frac{U_a^2}{R1} \text{ Watt}$$

5.5 Disturbance Recorder

The disturbance recorder can be initiated by starting, tripping, input or remote (disturbance). The total disturbance recording time is 6 records of 3 seconds, or $4 \times 4s$, or $3 \times 5s$, or $2 \times 7s$ or $1 \times 9s$. When the available memory space is used up, the new record automatically overwrites the oldest record.

The pre-time is the length of time before the disturbance. For example if the pre-time time is set to 100ms, the record starts 100 ms before the disturbance.

Note: Changing the record length and number will result in deletion of existing records. If necessary, read all wanted records before making changes.

The recorder stores actual samples that are taken at a rate of 32 samples per cycle. Each disturbance record consists of 5 analogue and 7 digital channels.

5.6 Autoreclose

Autoreclose is used for clearing transient/non-permanent fault. Autoreclose can minimize power blackout time and reduces the time and costs required for site servicing. With autoreclose, instantaneous protection can be used, which shorten the time to clear a fault and minimize damages and to reduce the number of permanent faults.

For recloser to function, the following setting is required:

1. One of the digital input function is CB Status 52A.
2. One of the output relay function is start/other, CB Close is assigned and reset method is auto (unlatched)
3. Output Relay 1 (trip) reset method is auto (unlatched).
4. Reclose cycle assigned to phase or earth cycle (>0).

The phase cycle and earth cycle are used to set the number of shots (reclose attempts), recloser can perform 2, 3 or 4 shot cycle. Dead times can be independently adjusted for each shots. The phase cycle is applied for tAux1 and tAux2 tripping also.

CYCLE setting (for tI>, tI>>, tI>>>, tIo>, tIo>>, tIo>>>, tAux 1, tAux2):

0: Recloser will move to lock status after tripping.

1: Tripping, followed by reclosing cycle.

2: No trip of pickup.

The dead time starts when the CB has opened (52A input deactivates) and the involved protection threshold reset. At the end of the relevant dead time, a CB close signal is sent. The reclaim time starts when the CB has closed (52A input activates). If no tripping after reclaim time elapsed, the recloser resets (reclose successful).

If tripping operates during reclaim time, the relay either advances to the next shot, or if all the reclose attempts have been accomplished, the recloser locks out (recloser final trip). The recloser will not be initiated for any fault during lockout.

CB Fail Alarm

If CB not open or close as expected for 2 seconds during reclose cycle, recloser locks out and CB Fail alarm generated.

Lockout Reset

After lockout the CB can be closed by control close input, CB close button or remote CB close command or by manual CB Close. The inhibit timer starts counting after CB close (52A input activates). When the timer elapsed, lockout condition reset.

Block Autoreclose Input

If this input activate during reclose cycle , recloser locks out.

If activate when recloser not running, next tripping is definitive trip.

Other Notes

- During reclose cycle, Close CB button, control close by input and remote CB close command is disabled. Open CB button and remote tripping command will lock the recloser.
- Maintenance mode will stop the reclose cycle without any locking. Power down the relay also stops the reclose cycle.
- If the relay receives an order to change setting group, the order will only be executed after the reclose cycle has elapsed.

5.7 Open CB & Close CB Control



Open CB : To manually open circuit breaker



Close CB : To manually close circuit breaker

The Open CB and Close CB button allows circuit breaker (CB) to be opened and closed from the relay front panel. Password is required for this operation. The control is available in the default display. The control will work with or without CB Status 52A input. Open CB control is using Output Relay 1 (Trip) for the signal.

For Open CB control, 'Remote' is assigned to output relay R1 or any other output relay with trip function. Otherwise the display shows "Remote Trip output not found"

For Close CB control, one of the output relay function should be start/other and 'CB Close' is assigned. Otherwise "CB close output not found" warning will be shown.

To Open CB

To open CB, press Open CB button once, password is required if not yet entered, then the display shows "Press again to open CB...", press Open CB button again to open the CB. Output relay 1 energize until CB Status 52A input deactivates. If CB Status 52A input is unavailable, Output relay 1 will energize for 2 seconds. The display shows "CB Opened" when CB opens successfully. If Open CB button press but CB already opened (CB Status 52A input deactivates), the display shows "CB is open" and ends.

To Close CB

To close CB, press Close CB button once, password is required if not yet entered. The display shows "Press again to close CB...", press Close CB button again to close the CB. Output relay for CB Close energize until CB Status 52A input activates. If CB Status 52A input is unavailable, Output relay will energize for 2 seconds. The display shows "CB Closed" when CB closes successfully.

If Close CB button press but CB already closed (CB Status 52A input energizes), the display shows "CB is close" and ends.

CB Fail Alarm

If CB Status 52A input is available and CB does not open or close after 2 seconds, CB Fail alarm generated.

5.8 Characteristic Curves

Normal Inverse

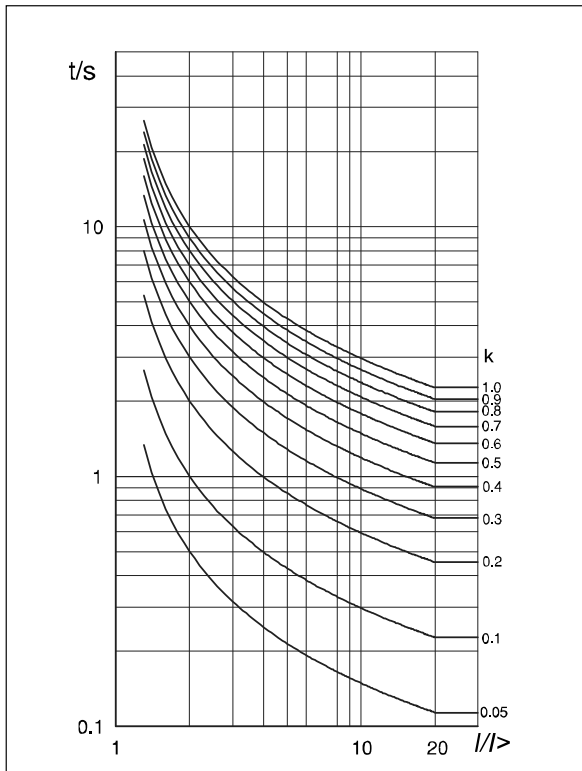

Very Inverse

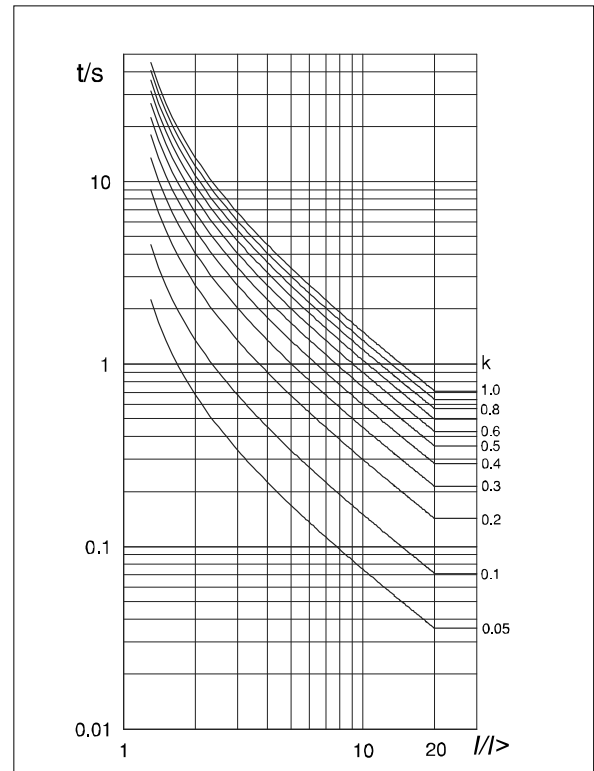

Normal Inverse 1.3/10

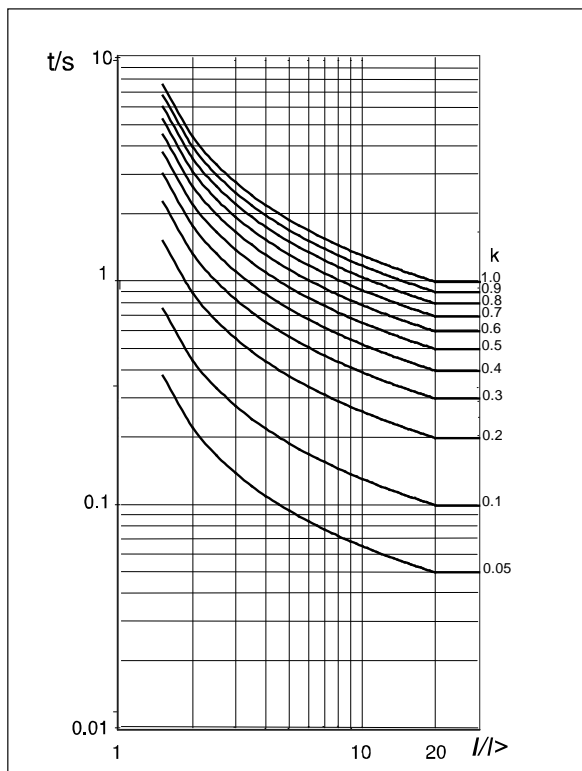

Long-time Inverse

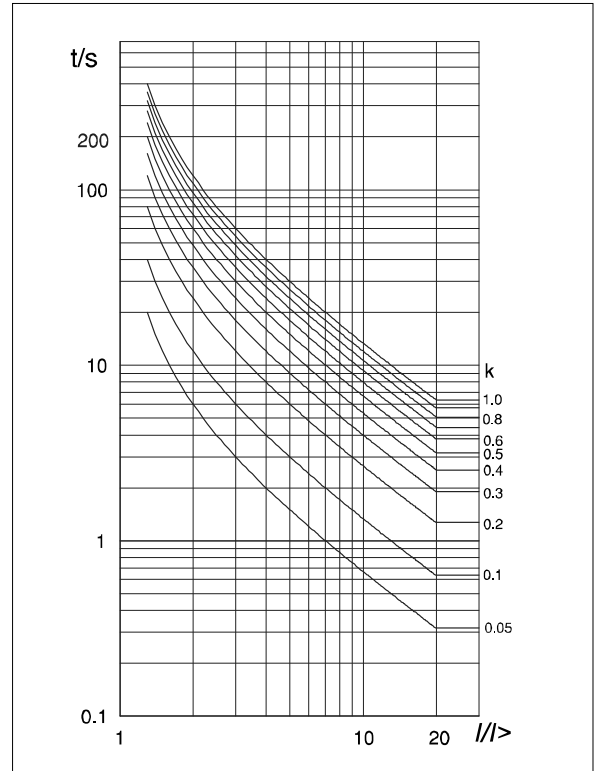

Extremely Inverse

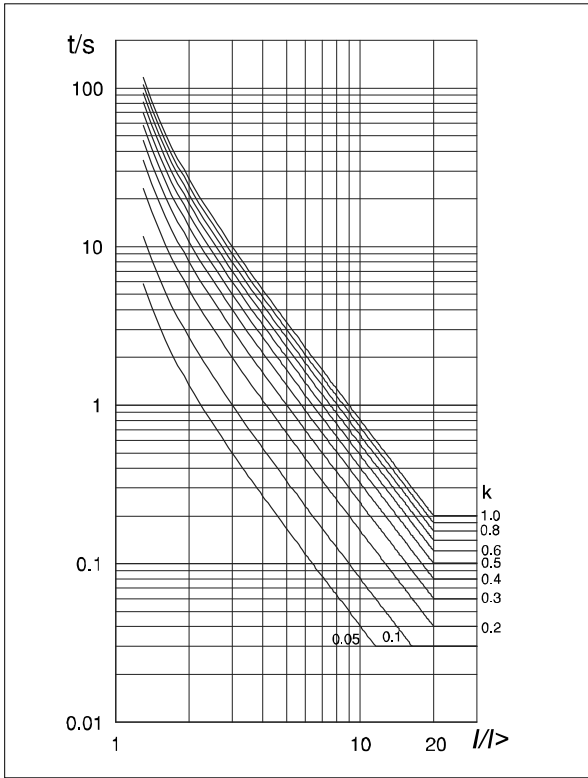

Thermal Overload Curves

($k=1.1, \theta_T = 10\text{minutes}$)

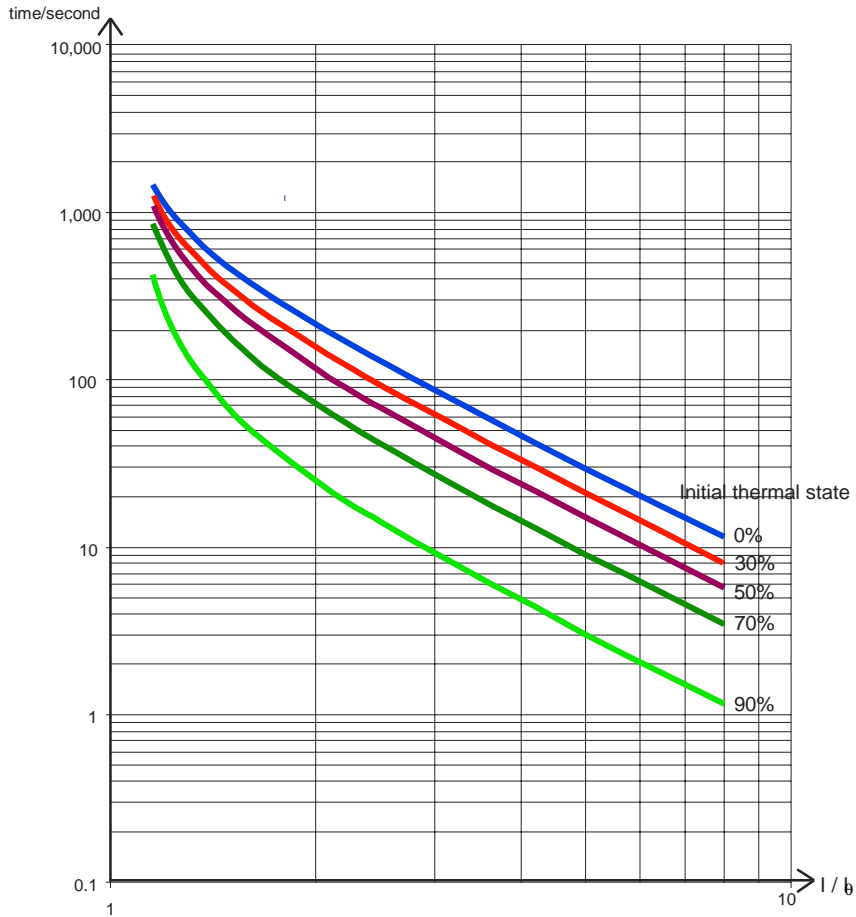

6.0 Case Dimensions

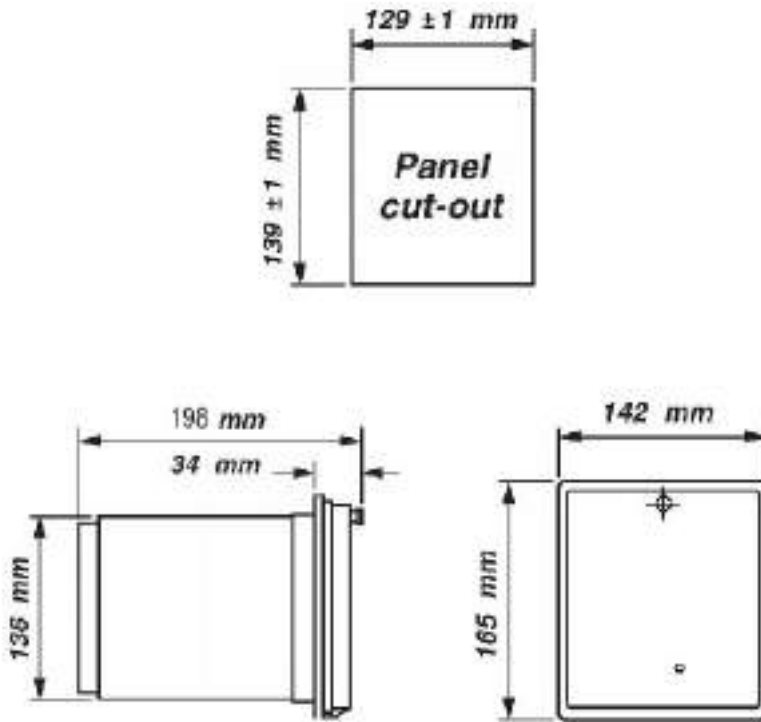

7.0 Connection Diagram and Terminal

7.1 Terminal Connection at Rear View

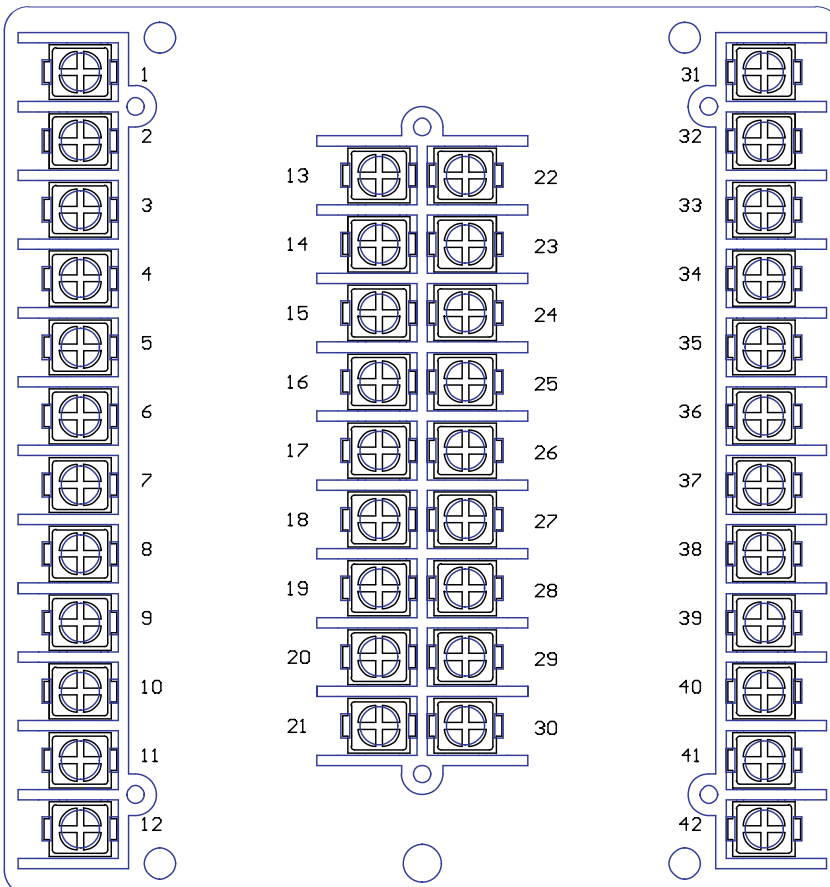

Connection terminal	Function Description
1	5A / 1A common CT input for IL1
2	5A CT input for IL1
3	1A CT input for IL1
4	5A / 1A common CT input for IL2
5	5A CT input for IL2
6	1A CT input for IL2
7	5A / 1A common CT input for IL3
8	5A CT input for IL3
9	1A CT input for IL3
10	5A / 1A common CT input for I ₀
11	5A CT input for I ₀
12	1A CT input for I ₀
13-17	Not used
18	Termination resistor for RS485 (shorting to 20 for termination)
19	RS485 positive terminal
20	RS485 negative terminal
21	RS485 cable shield
22	Not used
23-24	Output contact R3
25-26	Output contact R4
27-28	Digital Input 1 (no polarity)
29-30	Digital Input 2 (no polarity)
31	Casing earth terminal
32	Auxiliary supply input (no polarity)
33	Auxiliary supply input (no polarity)
34	Common contact for IRF
35	Normally open contact for IRF
36	Normally closed contact for IRF
37	Common contact for tripping contact R1
38	Normally open contact for tripping contact R1
39	Normally closed contact for tripping contact R1
40	Common contact for output contact R2
41	Normally open contact for output contact R2
42	Normally closed contact for output contact R2

7.2 Typical Connection Diagram

Example 1: With neutral. CT secondary 5A.

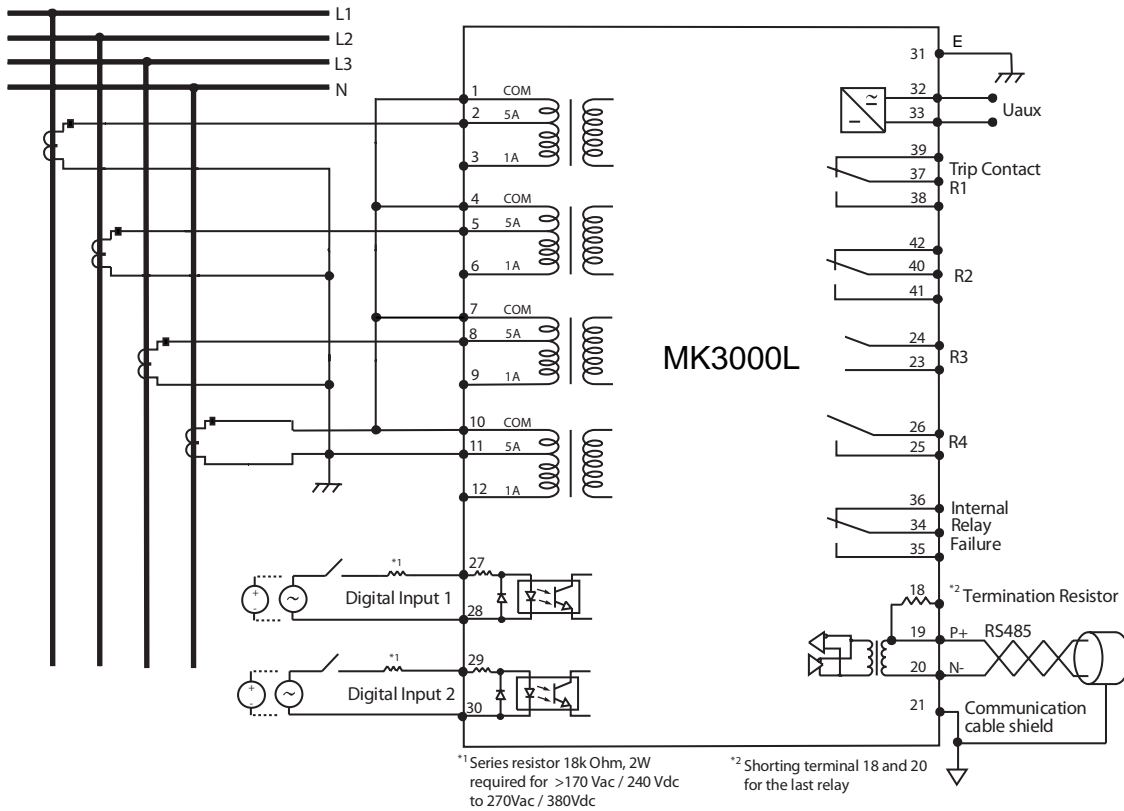

Example 2: Without neutral. CT secondary 1A.

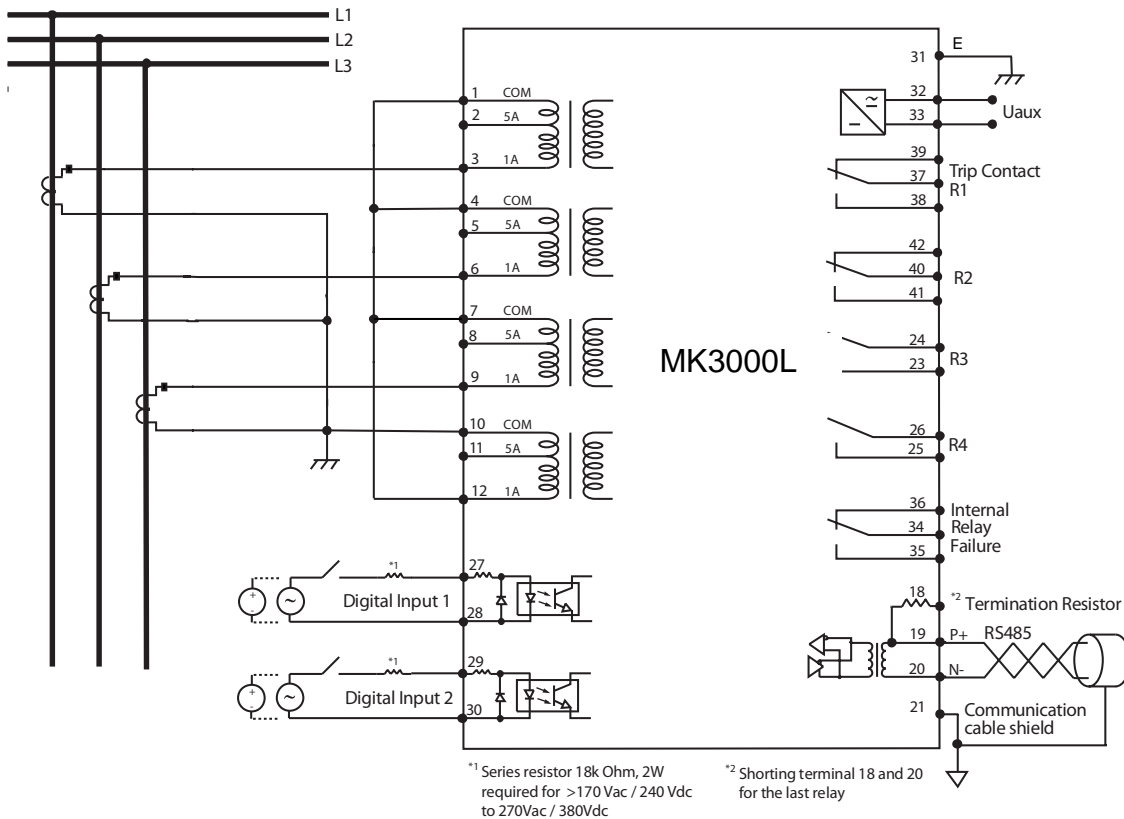

8.0 Technical Data

RATINGS

Auxiliary Supply

MK3000L-150D

Rated voltage : 30 ~ 120 V DC
Operating voltage : 24 ~ 150 V DC

MK3000L-240AD

Rated voltage : 100 ~ 240 V AC or 140 ~ 340 V DC
Operating voltage : 85 ~ 265 V AC or 110 ~ 370 V DC
Rated frequency : 50 or 60Hz
Operating frequency : 45 ~ 65 Hz

Power consumption : 8 VA max

Current Inputs

Rated current In : 1 or 5 A by connection
Frequency : 50 or 60 Hz nominal
Burden : < 0.025 VA (1A)
: < 0.3 VA (5A)
Thermal withstand : 4 x In continuous
: 40 x In for 2s
: 100 x In for 1s

Logic Inputs

Input type : Optically isolated
Rated voltage : 20 ~ 380 V DC
: 50 ~ 270 V AC
: (Series resistor 18k Ohm, 2W required for >170 V AC / 240 V DC direct input)

Output Relay

Trip Contact Relay (R1), R2, IRF Relay

Rated voltage : 250 V AC/DC
Contact arrangement : Change-over
Continuous carry : 5 A
Expected electrical life : 100,000 operations at rated load
Expected mechanical life : 5×10^6 operations

R3,R4

Rated load (resistive) : 5 A at 250 V AC
: 3 A at 30 V DC
Expected electrical life : 100,000 operations at rated load
Expected mechanical life : 5×10^6 operations

RECORDS

Fault Record : Up to 50 records.
Event Record : Up to 250 records
Alarm Record : Up to 30 records
Disturbance Record : See *Setting Ranges - Disturbance Record*

SETTING RANGES

General

Phase CT primary	: 1 to 10000 A. 1 to 1000: step 1; 1000 to 10000: step 5
Phase CT Secondary, In	: 1 or 5 A
Earth CT primary	: 1 to 10000 A. 1 to 1000: step 1; 1000 to 10000: step 5
Earth CT Secondary, Ion	: 1 or 5 A
Frequency	: 50 or 60 Hz

Phase Overcurrent

I>?	: Yes or No
I>	: 0.1 to 25 x In. *Variable steps. NOTE : When delay type is IDMT, the maximum setting recommended should be 2.00 x In.
I> Delay type	: IDMT or Definite Time
tI>	: 0 to 100 s. *Variable steps
I> IDMT curve	: Normal Inverse, Very Inverse, Extremely Inverse, Long-time Inverse, Normal Inverse 1.3/10
ktI	: 0.01 to 1.00
I>>?	: Yes or No
I>>	: 0.5 to 40 x In. *Variable steps
tI>>	: 0 to 100 s. *Variable steps
I>>>?	: Yes or No
I>>>	: 0.5 to 40 x In. *Variable steps
I>>> Sample	: Yes or No
tI>>>	: 0 to 100 s. *Variable steps

Earth Fault

Io?	: Yes or No
Io>	: 0.02 to 2 x Ion. *Variable steps NOTE : When delay type is IDMT, the maximum setting recommended should be 0.5 x Ion.
Io> Delay type	: IDMT or Definite Time
tIo>	: 0 to 100 s. *Variable steps
Io> IDMT curve	: Normal Inverse, Very Inverse, Extremely Inverse, Long-time Inverse, Normal Inverse 1.3/10
ktIo	: 0.01 to 1.00
Io>>?	: Yes or No
Io>>	: 0.1 to 10 x Ion. *Variable steps
tIo>>	: 0 to 100 s. *Variable steps
Io>>>?	: Yes or No
Io>>>	: 0.1 to 10 x In. *Variable steps
Io>>> Sample	: Yes or No
tIo>>>	: 0 to 100 s. *Variable steps

Negative Sequence Overcurrent

I2?	: Yes or No
I2>	: 0.1 to 40 x In. *Variable steps NOTE : When delay type is IDMT, the maximum setting recommended should be 2 x In.
I2> Delay type	: IDMT or Definite Time
tI2>	: 0 to 100 s. *Variable steps
I2> IDMT curve	: Normal Inverse, Very Inverse, Extremely Inverse, Long-time Inverse,

Normal Inverse 1.3/10
ktI2 : 0.01 to 1.00
I2>>? : Yes or No
I2>> : 0.1 to 40 x In. *Variable steps
tI2>> : 0 to 100 s. *Variable steps

Thermal Overload

Thermal OL? : Yes or No
Iθ> : 0.1 to 3.00 x In. *Variable steps
Tθ : 1 to 200 minutes. Step 1
k : 1 to 1.5. Step 0.01
θ Trip : 50 to 200%. Step 1%
θ Alarm : 50 to 200%. Step 1%

Demand Alarm

Demand Alarm? : Yes or No
Idmnd> : 0.10 to 20 x In. *Variable steps
tIdmnd> : 0.03 to 900 s. *Variable steps

Cold Load Pickup

CLPU Level : 100 to 500%.
CLPU tCL : 0.1 to 600 s

Disturbance Record

Records Number : 6 x 3s, 4 x 4s, 3 x 5s, 2 x 7s, 1 x 9s
Pre-Time : 0.1s to [record length - 0.1s]

Autoreclose

Dead Time tD1-tD4 : 0.05 to 600s
Reclaim Time tR : 0.02 to 600s
Inhibit Time tI : 0.02 to 600s
Phase Cycles : 0-4
Earth Cycles : 0-4
Cycles : 0-2 (0=Definitive trip, 1=trip on pickup, followed by reclose cycle,
2=no trip on pickup)

Inrush Blocking

Inrush blocking? : Yes or No
Inrush H2 ratio : 10 to 35%
Inrush tReset : 0 to 2s

Input

Aux timer : 0 to 600 s
TCS delay : 0.1 to 10 s. *Variable steps

Output

CBFP Delay : 0.05 to 10.0 s. *Variable steps.

Communication

Communication? : Yes or No
Remote Set? : Yes or No
Baud Rate : 2400, 4800, 9600, 19200, 38400 or 57600bps
Parity : None, Even or Odd

Stop Bit : 1 or 2
 Relay Address : 1 to 255

CB Alarm

CB Opening Time? : Yes or No
 CB Opening Time : 0.05 to 1s
 CB Closing Time? : Yes or No
 CB Closing time : 0.05 to 1s
 CB Operations? : Yes or No
 CB Operations : 0-10000
 ΣAmps(n)? : Yes or No
 ΣAmps(n) : 0 to 4000MA
 n : 1 or 2

*Variable steps: 0.1-1.00: step 0.01; 1.00-20: step 0.1; >20: step 1

MEASUREMENT RANGE

Phase, earth and negative sequence current Display : 0 to 999 kA. (Taking into account of CT Pri ratio)

Phase Current Secondary

5A input : 0 to 200 A
 1A input : 0 to 40 A

Earth Current Secondary

5A input : 0 to 50A
 1A input : 0 to 10A

Thermal θ : 0 to 9999%

Frequency : 20 to 80 Hz

CB Monitoring

CB Opening Time : 0-65535ms (65.535s)
 CB Closing Time : 0-65535ms (65.535s)
 CB Operations : 0-99999
 ΣAmps(n) IL1-IL3 : 0-4000MA

ACCURACY

Is: I>, I>> or I>>>

Ios: Io> or Io>>

Element	Range	Trigger	Reset	Time deviation
Phase overcurrent I>, I>>, I>>>	0.1 to 40 x In	Is ± 3% or 30mA whichever greater	0.95 x Is ± 2%	DT: ±2% +30ms IDMT: ±5% +30ms (>1.2 x Is)
Earth fault overcurrent Io>, Io>>	0.02 to 10 x Ion	Ios ± 3% or 30mA whichever greater	0.95 x Ios ± 2%	DT: ±2% +30ms IDMT: ±5% +30ms (>1.2 x Is)

Negative sequence overcurrent, I2>	0.1 to 40 x In	Is ± 5% or 30mA whichever greater	0.95 x Is ± 3%	DT: ±2% +30ms IDMT: ±6% +30ms (>1.2 x Is)
Thermal overload, Iθ>	0.1 to 3 x In			±5%

INSULATION

High voltage dielectric withstand test IEC60255-5 : 2kV rms, 1 minute
High voltage impulse test IEC60255-5 : 5kV, 1.2/50us

STANDARDS

Complies with IEC 60255-26 standard
Electrical fast transient IEC61000-4-4, power supply : 4kV, 5kHz
Electrical fast transient IEC61000-4-4, other inputs : 2kV, 5kHz
Surge IEC61000-4-5, IEC 60255-22-5 : 4kV common mode
: 2kV differential mode
Electrostatic discharge IEC61000-4-2, air discharge : 8 kV
Electrostatic discharge IEC61000-4-2, contact discharge : 6 kV
1MHz burst disturbance IEC60255-22-1 : 2kV Common mode
: 1kV Differential mode

Conducted Immunity IEC61000-4-6 : 10V rms @ 1kHz 80%AM, 0.15 to 80MHz
Radiated Immunity IEC61000-4-3 : 10V/m 80Mhz to 1GHz @ 1kHz 80% am
Conducted emissions : EN 55011 Group 1 Class B
Radiated EM Field emission : CISPR 11 Group 1 Class B

ENVIRONMENTAL CONDITIONS

Temperature : -5°C to 55°C
Humidity : 56 days at 93% RH and 40°C non-condensing

MECHANICAL

Mounting : Panel mounting
Dimension (mm) : 142(w) x 165(h) x 198(d)
Enclosure protection : IP54 at the panel
Approximate weight : 3kg

9.0 MODBUS Protocol

Both of the RS232 port on the front panel and the RS485 port on the rear terminals use MODBUS RTU protocol.

The RS232 front panel port is fixed to 38400bps, even parity, 1 stop bit, relay address 1.

The RS485 rear port communication setting is set by the COMMUNICATION Menu from the front panel.

9.1 MODBUS Functions

The MODBUS functions described below are used:

0x03/0x04 Read Input/Holding Registers

These 2 commands have the same function

Request	Communication address	1 byte	0* to 255
	Function code	1 byte	0x03/0x04
	Starting Address	2 bytes	0x0000 to 0xFFFF
	Quantity of Registers	2 bytes	0x0001 to 0x007d (N)
	CRC	2 bytes	2 bytes CRC

Response	Communication address	1 byte	1 to 255
	Function code	1 byte	0x03/0x04
	Byte count	1 bytes	2 X N
	Quantity of Registers	N X 2 bytes	Value
	CRC	2 bytes	2 bytes CRC

Error	communication address	1 byte	1 to 255
	Error code	1 byte	0x83/0x84
	Exception code	1 bytes	0x01 or 02 or 03 or 04
	CRC	2 bytes	2 bytes CRC

0x06 Write Single Register

Request	Communication address	1 byte	0* to 255
	Function code	1 byte	0x06
	Register Address	2 bytes	0x0000 to 0xFFFF
	Register value	2 bytes	Value
	CRC	2 bytes	2 bytes CRC

Response	Communication address	1 byte	1 to 255
	Function code	1 byte	0x06
	Register value	2 bytes	value
	CRC	2 bytes	2 bytes CRC

Error	Communication address	1 byte	1 to 255
	Error code	1 byte	0x86
	Exception code	1 bytes	0x01 or 02 or 03 or 04
	CRC	2 bytes	2 bytes CRC

0x10 Write Multiple Registers

Request	Communication address	1 byte	0* to 255
	Function code	1 byte	0x10
	Starting Address	2 bytes	0x0000 to 0xFFFF
	Quantity of Registers	2 bytes	0x0001 to 0x007b (N)
	Byte count	1 byte	2 X N
	Register value	N X 2 bytes	Value
	CRC	2 bytes	2 bytes CRC

Response	Communication address	1 byte	1 to 255
	Function code	1 byte	0x10
	Quantity of Registers	2 bytes	0x0001 to 0x007b (N)
	CRC	2 bytes	2 bytes CRC

Error	Communication address	1 byte	1 to 255
	Error code	1 byte	0x90
	Exception code	1 bytes	0x01 or 02 or 03 or 04
	CRC	2 bytes	2 bytes CRC

*Note: communication address 0 is a broadcast command to all the slaves. The slave will not respond a broadcast command.

9.2 MODBUS Register

*Note: For MK3000L, Device type – main is 00 02 03. Device type –sub is 00.

Address		Parameter	Format	Units and Scale	Range
Dec	Hex				
Product information. Read only. Function 03h or 04h					
0	0000		F1	ASCII	'00'
1	0001	Device type - main*	F1	ASCII	'02'
2	0002		F1	ASCII	'03'
3	0003	Device type - sub*	F1	ASCII	'00'
4	0004	Version number -main	F1	ASCII	'XX'
5	0005		F1	ASCII	'XX'
6	0006	Version number -sub	F1	ASCII	'XX'
7	0007		F1	ASCII	'XX'
Measurements and relay status. Read only. Function 03h or 04h					
16	0010	Relay status	F2	Bit field	Bit 0 - 15
17	0011	Relay LED status	F3	Bit field	Bit 0 - 11
18	0012	Input status	F4	Bit field	Bit 0 - 3
19	0013	Output status	F5	Bit field	Bit 0 - 4
20	0014	Active group	F6	--	0=group 1, 1=group 2
21	0015	Thermal State	F7	%	0-9999
22	0016	IL1 high word	F8	0.01 Ampere	0-9.99x10 ⁷ (999kA)
23	0017	IL1 low word			
24	0018	IL2 high word	F8	0.01 Ampere	0-9.99x10 ⁷ (999kA)
25	0019	IL2 low word			
26	001A	IL3 high word	F8	0.01 Ampere	0-9.99x10 ⁷ (999kA)
27	001B	IL3 low word			
28	001C	Io high word	F8	0.01 Ampere	0-9.99x10 ⁷ (999kA)
29	001D	Io low word			
30	001E	IL1 Max high word	F8	0.01 Ampere	0-9.99x10 ⁷ (999kA)
31	001F	IL1 Max low word			
32	0020	IL2 Max high word	F8	0.01 Ampere	0-9.99x10 ⁷ (999kA)
33	0021	IL2 Max low word			
34	0022	IL3 Max high word	F8	0.01 Ampere	0-9.99x10 ⁷ (999kA)
35	0023	IL3 Max low word			
36	0024	Io Max high word	F8	0.01 Ampere	0-9.99x10 ⁷ (999kA)
37	0025	Io Max low word			
38	0026	IL1 Avg high word	F8	0.01 Ampere	0-9.99x10 ⁷ (999kA)
39	0027	IL1 Avg low word			
40	0028	IL2 Avg high word	F8	0.01 Ampere	0-9.99x10 ⁷ (999kA)
41	0029	IL2 Avg low word			
42	002A	IL3 Avg high word	F8	0.01 Ampere	0-9.99x10 ⁷ (999kA)
43	002B	IL3 Avg low word			
44	002C	Io Avg high word	F8	0.01 Ampere	0-9.99x10 ⁷ (999kA)
45	002D	Io Avg low word			
46	002E	Line Frequency	F7	0.01 Hz	0-10000 (0-100Hz)
47	002F	I2 high word	F8	0.01 Ampere	0-9.99x10 ⁷ (999kA)
48	0030	I2 low word			
49	0031	Relay status 2	F25	Bit field	Bit 0-2
50	0032	CB Opening Time	F7	ms	0-65535 (65.535s)
51	0033	CB Closing Time	F7	ms	0-65535 (65.535s)
52	0034	CB Operations high word	F8	--	0-99999
53	0035	CB Operations low word			
54	0036	\sum Amps(n) I1 high word	F8	Ampere	0-4000x10 ⁶ (4000MA)
55	0037	\sum Amps(n) I1 low word			
56	0038	\sum Amps(n) I2 high word	F8	Ampere	0-4000x10 ⁶ (4000MA)
57	0039	\sum Amps(n) I2 low word			
58	003A	\sum Amps(n) I3 high word	F8	Ampere	0-4000x10 ⁶ (4000MA)
59	003B	\sum Amps(n) I3 low word			
Remote command. Write only. Function 06h					
256	0100	Remote Command	F9	Bit field	--
Settings. Read/Write. Function 03h, 04h, 06h, 10h					
512	0200	Phase CT Primary	F7	Ampere	1 - 10000
513	0201	Phase CT Secondary, In	F6	Ampere	0=1, 1=5
514	0202	Earth/Ground CT Primary	F7	Ampere	1 - 10000
515	0203	Earth/Ground CT Secondary, Ion	F6	Ampere	0=1, 1=5
516	0204	Frequency	F6	--	0=50Hz, 1=60 Hz
517	0205	Time Window for Average and Maximum Current	F7	minute	1 - 60
518	0206	Year	F7	year	0 - 199 (as 2000 - 2199)
519	0207	month, day	F10	month,day	0 - 12, 0 - 31
520	0208	hour, minute	F11	hour, minute	0 - 23, 0 - 59
521	0209	Milliseconds	F7	ms	0 - 59999

Address		Parameter	Format	Units and Scale	Range
Dec	Hex				
525	020D	LCD backlight on duration	F7	minute	1 - 60
526	020E	LCD backlight brightness	F6	--	0=low, 1=medium, 2=high
527	020F	'Clear' key to scroll settings	F6	--	0=No, 1=Yes
528	0210	Communication? (Unused)	F6	--	0=No, 1=Yes
529	0211	Communication Baud Rate	F6	--	0=2400, 1=4800, 2=9600, 3=19200, 4=38400
530	0212	Communication Parity	F6	--	0=None, 1=Odd, 2=Even
531	0213	Communication Stop Bit	F6	--	0=1bit, 1=2bits
532	0214	Communication Address	F7	--	1 - 255
533	0215	Password	F7	--	0
534-543	0216-021F	Reserved - read as 0, write to void			
544	0220	Demand Alarm	F6	--	Bit 0: 0=No, 1=Yes. High byte=delay time msb
545	0221	ldemand> threshold	F14	0.01 In	10-2000 (0.1 - 20)
546	0222	ldemand> delay time	F14	0.01s	0 - 90000 (0 - 900s) (combine with high byte 0221)
547-559	0223-022F	Reserved - read as 0, write to void			
560	0230	Cold Load Pick-up Level	F7	%	100-500%
561	0231	Cold Load Pick-up tCL	F14	0.01s	10-60000 (0.1-600s)
562	0232	Cold Load Pick-up element	F15	Bit field	Bit 0-5
563-575	0233-023F	Reserved - read as 0, write to void			
576	0240	Input 1 Function/Type	F22	--	--
577	0241	Input 1 Reset Option	F16	Bit field	Bit 0 - 1
578	0242	Input 1 Blocking element	F17	Bit field	Bit 0 - 5
579	0243	Input 1 Aux delay	F14	0.01s	0 - 60,000 (600s)
580	0244	Input 1 TCS delay	F14	0.01s	0 - 1000 (10s)
581	0245	Input 2 Function/Type	F21	--	--
582	0246	Input 2 Reset Option	F16	Bit field	Bit 0 - 1
583	0247	Input 2 Blocking element	F17	Bit field	Bit 0 - 5
584	0248	Input 2 Aux delay	F14	0.01s	0 - 60,000 (600s)
585	0249	Input 2 TCS delay	F14	0.01s	0 - 1000 (10s)
586-622	024A-026E	Reserved - read as 0, write to void			
623	026F	IRF Option	F6	--	0=No, 1=Yes
624	0270	Relay 1 Function	F6	--	2=trip (read only, write to void). Bit 7: 0=Manual (latched), 1=auto reset (unlatched)
625	0271	Relay 1 Linked element 1	F18	Bit field	Bit 0-13
626-628	0272-0274	Reserved - read as 0, write to void			
629	0275	Relay 2 Function/Reset option	F6	--	0=none, 1=start/other, 2=trip, 3=upstream trip. Bit 7: 0=Manual (latched), 1=auto reset (unlatched)
630	0276	Relay 2 Linked element 1	F18	Bit field	Bit 0-13
631	0277	Relay 2 Linked element 2	F19	Bit field	Bit 0-4
632	0278	Relay 2 CBFP option	F6	--	0=exclude Aux input, 1=include Aux input
633	0279	Relay 2 CBFP delay	F14	0.01s	5 - 1000 (50ms - 10s)
634	027A	Relay 3 Function/Reset option	F6	--	0=none, 1=start/other, 2=trip, 3=upstream trip. Bit 7: 0=Manual (latched), 1=auto reset (unlatched)
635	027B	Relay 3 Linked element 1	F18	Bit field	Bit 0-13
636	027C	Relay 3 Linked element 2	F19	Bit field	Bit 0-4
637	027D	Relay 3 CBFP option	F6	--	0=exclude Aux input, 1=include Aux input
638	027E	Relay 3 CBFP delay	F14	0.01s	5 - 1000 (50ms - 10s)
639	027F	Relay 4 Function/Reset option	F6	--	0=none, 1=start/other, 2=trip, 3=upstream trip. Bit 7: 0=Manual (latched), 1=auto reset (unlatched)
640	0280	Relay 4 Linked element 1	F18	Bit field	Bit 0-13
641	0281	Relay 4 Linked element 2	F19	Bit field	Bit 0-4
642	0282	Relay 4 CBFP option	F6	--	0=exclude Aux input, 1=include Aux input
643	0283	Relay 4 CBFP delay	F14	0.01s	5 - 1000 (50ms - 10s)
1792	0700	CB Open Time?	F6	--	0=No, 1=Yes
1793	0701	CB Open Time	F14	0.01s	5 - 100 (50ms - 1s)
1794	0702	CB Close Time?	F6	--	0=No, 1=Yes
1795	0703	CB Close Time	F14	0.01s	5 - 100 (50ms - 1s)
1796	0704	CB Operations?	F6	--	0=No, 1=Yes
1797	0705	CB Operations	F7	--	1 - 10000
1798	0706	Σamps(n)?	F6	--	0=No, 1=Yes
1799	0707	Σamps(n)	F7	MA	0 - 4000 (0-4000MA)
1800	0708	n	F7	--	1 - 2
1801-1807	0709-70F	Reserved - read as 0, write to void			
1808	0710	Disturbance record number	F23	--	0-5
1809	0711	Disturbance record Pre-Time	F14	0.01s	0 - 290 (2.9s)
1810	0712	Disturbance record trigger	F6	--	0=On Inst, 1=On Trip
1811-1823	0713-71F	Reserved - read as 0, write to void			
1824	0720	LED 1 Linked element 1	F20	Bit field	Bit 0-15
1825	0721	LED 1 Linked element 2	F21	Bit field	Bit 0-15
1826	0722	LED 2 Linked element 1	F20	Bit field	Bit 0-15
1827	0723	LED 2 Linked element 2	F21	Bit field	Bit 0-15
1828	0724	LED 3 Linked element 1	F20	Bit field	Bit 0-15
1829	0725	LED 3 Linked element 2	F21	Bit field	Bit 0-15
1830	0726	LED 4 Linked element 1	F20	Bit field	Bit 0-15
1831	0727	LED 4 Linked element 2	F21	Bit field	Bit 0-15
1832-1839	0727-072F	Reserved - read as 0, write to void			
1840	0730	Inrush Blocking?	F6	--	0=No, 1=Yes
1841	0731	Inrush 2nd Harmonics Ratio	F14	0.1%	100-350 (10-35%)
1842	0732	Inrush tReset	F14	0.01s	0 - 200 (0-2s)
1843	0733	Inrush Blocking Element	F26	Bit field	Bit 0-7

Address		Parameter	Format	Units and Scale	Range
Dec	Hex				
Protection Group 1					
768	0300	Thermal Overload?	F6	--	0=Disable, 1=Enable
769	0301	Thermal Full Load Current, I _θ	F14	0.01 In	10 - 300 (0.1-3)
770	0302	Thermal Time Constant, T _θ	F7	minute	1 - 200
771	0303	Thermal Factor, k	F14	0.01	100-150 (1-1.5)
772	0304	Thermal Trip Threshold	F7	%	50 - 200
773	0305	Thermal Alarm Threshold	F7	%	50 - 200
774-783	0306-030F	Reserved - read as 0, write to void			
784	0310	I> ?	F6	--	0=Disable, 1=Enable
785	0311	I> Threshold	F14	0.01 In	10-2500 (0.1 - 25)
786	0312	I> Delay Type	F6	--	0=definite time, 1=IDMT
787	0313	tI> Definite Time	F14	0.01s	0 - 10000 (0 - 100s)
788	0314	I> IDMT Curve	F6	--	0=NI, 1=VI, 2=EI, 3=LTI, 4=NI1
789	0315	ktI> IDMT time multiplier	F14	0.01	1 - 100 (0.01 - 1)
790-799	0316-031F	Reserved - read as 0, write to void			
800	0320	I>> ?	F6	--	0=Disable, 1=Enable
801	0321	I>> Threshold	F14	0.01 In	50 - 4000 (0.5-40)
802	0322	tI>> Definite time	F14	0.01s	0 - 10000 (0 - 100s)
803-809	0323-0329	Reserved - read as 0, write to void			
810	032A	I>>> ?	F6	--	0=Disable, 1=Enable
811	032B	I>>> Sample	F6	--	0=No, 1=Yes
812	032C	I>>> Threshold	F14	0.01 In	50 - 4000 (0.5-40)
813	032D	tI>>> Definite time	F14	0.01s	0 - 10000 (0 - 100s)
814-815	032E-032F	Reserved - read as 0, write to void			
816	0330	Earth Fault I0> ?	F6	--	0=Disable, 1=Enable
817	0331	Earth Fault I0> Threshold	F14	0.01 Ion	2-200 (0.02 - 2)
818	0332	Earth Fault I0> Delay Type	F6	--	0=definite time, 1=IDMT
819	0333	Earth Fault Definite Time tI0>	F14	0.01s	0 - 10000 (0 - 100s)
820	0334	Earth Fault IDMT Curve	F6	--	0=NI, 1=VI, 2=EI, 3=LTI, 4=NI1
821	0335	Earth Fault IDMT Multiplier kI0>	F14	0.01	1 - 100 (0.01 - 1)
822-831	0336-0339	Reserved - read as 0, write to void			
832	0340	Earth Fault I0>> ?	F6	--	0=Disable, 1=Enable
833	0341	Earth Fault I0>> Threshold	F14	0.01 Ion	10 - 1000 (0.1-10)
834	0342	Earth Fault tI0>>	F14	0.01s	0 - 10000 (0 - 100s)
835-841	0343-0349	Reserved - read as 0, write to void			
842	034A	Earth Fault I0>>> ?	F6	--	0=Disable, 1=Enable
843	034B	Earth Fault I0>>> Sample	F6	--	0=No, 1=Yes
844	034C	Earth Fault I0>>> Threshold	F14	0.01 In	10 - 1000 (0.1-10)
845	034D	Earth Fault tI0>>> Definite time	F14	0.01s	0 - 10000 (0 - 100s)
846-847	034E-034F	Reserved - read as 0, write to void			
848	0350	I2> ?	F6	--	0=Disable, 1=Enable
849	0351	I2> Threshold	F14	0.01 In	10-4000 (0.1 - 40)
850	0352	I2> Delay Type	F6	--	0=definite time, 1=IDMT
851	0353	tI2> Definite Time	F14	0.01s	0 - 10000 (0 - 100s)
852	0354	I2> IDMT Curve	F6	--	0=NI, 1=VI, 2=EI, 3=LTI, 4=NI1
853	0355	ktI2> IDMT time multiplier	F14	0.01	1 - 100 (0.01 - 1)
854-863	0356-035F	Reserved - read as 0, write to void			
864	0360	I2>> ?	F6	--	0=Disable, 1=Enable
865	0361	I2>> Threshold	F14	0.01 In	10 - 4000 (0.1-40)
866	0362	tI2>> Definite time	F14	0.01s	0 - 10000 (0 - 100s)
867-879	0363-036F	Reserved - read as 0, write to void			
880	0370	Autoreclose?	F6	--	0=Disable, 1=Enable
881	0371	Dead Time, tD1	F14	0.01s	5-60000 (0.05-600s)
882	0372	Dead Time, tD2	F14	0.01s	5-60000 (0.05-600s)
883	0373	Dead Time, tD3	F14	0.01s	5-60000 (0.05-600s)
884	0374	Dead Time, tD4	F14	0.01s	5-60000 (0.05-600s)
885	0375	Reclaim Time, tR	F14	0.01s	2-60000 (0.02-600s)
886	0376	Inhibit Time, tI	F14	0.01s	2-60000 (0.02-600s)
887	0377	Phase Cycles	F7	Cycle	0-4
888	0378	E/Gnd Cycles	F7	Cycle	0-4
889	0379	tI> Cycles	F24	Cycles 4 3 2 1	bit 0-1: cycle 1, bit 2-3 cycle 2, 0000 to 2222
890	037A	tI>> Cycles	F24	Cycles 4 3 2 1	Hex 0x0 to 0xAA
891	037B	tI>>> Cycles	F24	Cycles 4 3 2 1	Hex 0x0 to 0xAA
892	037C	tI0> Cycles	F24	Cycles 4 3 2 1	Hex 0x0 to 0xAA
893	037D	tI0>> Cycles	F24	Cycles 4 3 2 1	Hex 0x0 to 0xAA
894	037E	tI0>>> Cycles	F24	Cycles 4 3 2 1	Hex 0x0 to 0xAA
895	037F	tAux 1 Cycles	F24	Cycles 4 3 2 1	Hex 0x0 to 0xAA
896	0380	tAux 2 Cycles	F24	Cycles 4 3 2 1	Hex 0x0 to 0xAA
Protection Group 2					
1024-1152	0400-0480	Same as Protection Group1 except addresses are 04xx instead of 03xx			

Fault Record

Address		Parameter	Format	Units and Scale	Range
Dec	Hex				
Fault Records. Read only. Function 03h or 04h					
4096	1000	Fault Record 1			
4097	1001	Fault Record 2			
:	:				
:	:				
4145	1031	Fault Record 50			

Each Fault Record consists of 16 words:

Fault record words

Word Number	Description	Format	Units and scale	Range
1	Year	F7	year	0 - 199 (as 2000 - 2199)
2	month, day	F10	month, day	0 - 12, 0 - 31
3	hour, minute	F11	hour, minute	0 - 23, 0 - 59
4	Milliseconds	F7	ms	0 - 59999
5	setting group	F7	--	0 - 1 (as group 1 - 2)
6	source & threshold	See below	source, threshold	0 - 14, 0 - 11
7	Value high word	F8	0.01 Ampere or 0.1% thermal	0-9.99x10 ⁷ (999kA) or 500-2000
8	Value low word			
9	IL1 high word	F8	0.01 Ampere	0-9.99x10 ⁷ (999kA)
10	IL1 low word			
11	IL2 high word	F8	0.01 Ampere	0-9.99x10 ⁷ (999kA)
12	IL2 low word			
13	IL3 high word	F8	0.01 Ampere	0-9.99x10 ⁷ (999kA)
14	IL3 low word			
15	lo high word	F8	0.01 Ampere	0-9.99x10 ⁷ (999kA)
16	lo low word			

Word number 6:

High byte: Fault record source code

Bit 0: IL1
 Bit 1: IL2
 Bit 2: IL3
 8: lo
 9: Thermal
 10: Aux 1
 11: Aux 2
 12: TCS
 13: Remote
 14: I2

Low byte: Fault record threshold

0: tl>
 1: tl>>
 2: tl>>>
 3: tlo>
 4: tlo>>
 5: Thermal Overload
 6: tAux 1
 7: tAux 2
 8: Reserved
 9: Reserved
 10: Remote trip
 11: tl2>
 12: tl2>>
 13: tlo>>>

Event Record

Address		Parameter	Format	Units and Scale	Range
Dec	Hex				
Event Records. Read only. Function 0x03 or 0x04					
8192	2000	Record 1			
8193	2001	Record 2			
:	:				
:	:				
8441	20F9	Record 250			
Alarm Records. Read only. Function 0x03 or 0x04					
12288	3000	Record 1			
12289	3001	Record 2			
:	:				
:	:				
12317	301D	Record 30			

Each Event or Alarm Record consists of 8 words:

Word Number	Description	Format	Units and scale	Range
1	Year	F7	year	0 - 199 (as 2000 - 2199)
2	month, day	F10	month,day	0 - 12, 0 - 31
3	hour, minute	F11	hour, minute	0 - 23, 0 - 59
4	Milliseconds	F7	ms	0 - 59999
5	Record code	See below	record code	
6	Record value	See below	record value	
7	Record fault value	F8	0.01 Ampere	0-9.99x10 ⁷ (999kA)
8	Record fault value			

Word number 5:

Event and Alarm Record code

0: None

1: l> start

2: tl> trip

3: l>> start

4: tl>> trip

5: l>>> start

6: tl>>> trip

7: lo> start

8: tlo>> trip

9: lo>> start

10: tlo>> trip

11: Remote trip

12: Remote acknowledge

13: Remote reset

14: Setting change

15: Remote thermal state reset

16: Maintenance mode

17: Thermal alarm

18: Thermal overload

19: TCS alarm

20: Group change

21: tAux 1

22: tAux 2

23: tl> reset

24: tl>> reset

25: tl>>> reset

26: tlo> reset

27: tlo>> reset

28: Relay latching

29: Relay unlatching

30: Input activate

31: Input deactivate

32: Idemand alarm

33: General starting

34: Cold load function starting

35: l2> start

36: tl2> trip

37: l2>> start

38: tl2>> trip

39: tl2> reset

40: tl2>> reset

41: lo>>> start

42: tlo>>> trip

43: tlo>>> reset

44: CB Fail

45: Recloser setting error

46: Reclose successful

47: Recloser final trip

48: Recloser locked

49: CB closed by autorecloser

50: Control CB close (input & button)

51: CB remote close

52: CB control open (button)

53: CB Alarm

54: No CB Close Output

55: Inrush blocking

Word number 6:

Event and Alarm Record value

If code is l> start, tl> trip, l>> start, tl>> trip, l>>> start, tl>>> trip,

Demand alarm:

Bit 0: IL1

Bit 1: IL2

Bit 2: IL3

If code is Setting change:

Value is the register address of setting being changed

If code is thermal alarm, thermal overload Value is the % of thermal alarm or overload threshold:

If code is Group change:

0: group 1

1: group 2

If code is output relay latching, output relay unlatching:

Bit 0: Output relay 1

Bit 1: Output relay 2

Bit 2: Output relay 3

Bit 3: Output relay 4

If code is input activate, input deactivate:

Bit 0: Input 1

Bit 1: Input 2

If code is tAux 1, tAux 2:

0=Alarm

0x8000=Trip

Word number 7,8:

Fault current value for

tl>,tl>>,tl>>>,tlo>,tlo>>,tlo>>>,tl2>,tl2>>

Steps to read Disturbance records:

1. Read 3100 to find out number of disturbance records available
2. Select one of the record number and channel by reading 3200-3705.
3. Read from 4000 the selected record number and channel until total number in the mapping read.
4. Use the information obtained from 2 for plotting also.

Address		Parameter	Format	Units and Scale	Range
Dec	Hex				
Number of disturbance records available. Read only. Function 0x03 or 0x04					
12544	3100	Number of disturbance records available			

Address: 3100

Number of disturbance records available

Word Number	Description	Format	Units and scale	Range	
1	No of disturbance records available	F7		0-5	
2	Rec 1 Available, Acknowledge	F7		0-1, 0-1	*1
3	Rec 1 year	F7	year	0 - 199 (as 2000 - 2199)	*3
4	Rec 1 month, day	F10	month,day	0 - 12, 0 - 31	*3
5	Rec 1 hour, minute	F11	hour, minute	0 - 23, 0 - 59	*3
6	Rec 1 millisecond	F7	ms	0 - 59999	*3
7	Rec 1 Disturbance record trigger	F7		1-4	*2
8	Rec 2 Available, Acknowledge	F7		0-1, 0-1	*1
9	Rec 2 year	F7	year	0 - 199 (as 2000 - 2199)	*3
10	Rec 2 month, day	F10	month,day	0 - 12, 0 - 31	*3
11	Rec 2 hour, minute	F11	hour, minute	0 - 23, 0 - 59	*3
12	Rec 2 millisecond	F7	ms	0 - 59999	*3
13	Rec 2 Disturbance record trigger	F7		1-4	*2
14	Rec 3 Available, Acknowledge	F7		0-1, 0-1	*1
15	Rec 3 year	F7	year	0 - 199 (as 2000 - 2199)	*3
16	Rec 3 month, day	F10	month,day	0 - 12, 0 - 31	*3
17	Rec 3 hour, minute	F11	hour, minute	0 - 23, 0 - 59	*3
18	Rec 3 millisecond	F7	ms	0 - 59999	*3
19	Rec 3 Disturbance record trigger	F7		1-4	*2
20	Rec 4 Available, Acknowledge	F7		0-1, 0-1	*1
21	Rec 4 year	F7	year	0 - 199 (as 2000 - 2199)	*3
22	Rec 4 month, day	F10	month,day	0 - 12, 0 - 31	*3
23	Rec 4 hour, minute	F11	hour, minute	0 - 23, 0 - 59	*3
24	Rec 4 millisecond	F7	ms	0 - 59999	*3
25	Rec 4 Disturbance record trigger	F7		1-4	*2
26	Rec 5 Available, Acknowledge	F7		0-1, 0-1	*1
27	Rec 5 year	F7	year	0 - 199 (as 2000 - 2199)	*3
28	Rec 5 month, day	F10	month,day	0 - 12, 0 - 31	*3
29	Rec 5 hour, minute	F11	hour, minute	0 - 23, 0 - 59	*3
30	Rec 5 millisecond	F7	ms	0 - 59999	*3
31	Rec 5 Disturbance record trigger	F7		1-4	*2
32	Rec 6 Available, Acknowledge	F7		0-1, 0-1	*1
33	Rec 6 year	F7	year	0 - 199 (as 2000 - 2199)	*3
34	Rec 6 month, day	F10	month,day	0 - 12, 0 - 31	*3
35	Rec 6 hour, minute	F11	hour, minute	0 - 23, 0 - 59	*3
36	Rec 6 millisecond	F7	ms	0 - 59999	*3
37	Rec 6 Disturbance record trigger	F7		1-4	*2

*1: Record number read as 0 if not available. Acknowledge: 0=unread, 1=read

If record is not available the related words read as 0 also.

*2: 1=trip, 2=instantaneous, 3=remote, 4=input

*3: The Time is the trigger point of the disturbance record.

Address		Parameter	Format	Units and Scale	Range
Dec	Hex				
Selection of disturbance record and channel. Read only. Function 0x03 or 0x04. Only 1 address being read at a time.					
12800	3200	Record number 1, IL1			
12801	3201	Record number 1, IL2			
12802	3202	Record number 1, IL3			
12803	3203	Record number 1, lo			
12804	3204	Record number 1, Frequency			
12805	3205	Record number 1, Digital input and outputs			
13056	3300	Record number 2, IL1			
13057	3301	Record number 2, IL2			
13058	3302	Record number 2, IL3			
13059	3303	Record number 2, lo			
13060	3304	Record number 2, Frequency			
13061	3305	Record number 2, Digital input and outputs			
13312	3400	Record number 3, IL1			
13313	3401	Record number 3, IL2			
13314	3402	Record number 3, IL3			
13315	3403	Record number 3, lo			
13316	3404	Record number 3, Frequency			
13317	3405	Record number 3, Digital input and outputs			
13568	3500	Record number 4, IL1			
13569	3501	Record number 4, IL2			
13570	3502	Record number 4, IL3			
13571	3503	Record number 4, lo			
13572	3504	Record number 4, Frequency			
13573	3505	Record number 4, Digital input and outputs			
13824	3600	Record number 5, IL1			
13825	3601	Record number 5, IL2			
13826	3602	Record number 5, IL3			
13827	3603	Record number 5, lo			
13828	3604	Record number 5, Frequency			
13829	3605	Record number 5, Digital input and outputs			
14080	3700	Record number 6, IL1			
14081	3701	Record number 6, IL2			
14082	3702	Record number 6, IL3			
14083	3703	Record number 6, lo			
14084	3704	Record number 6, Frequency			
14085	3705	Record number 6, Digital input and outputs			
Disturbance record data. Read only. Function 0x03 or 0x04					
16384	4000	125 disturbance data words page 1			
16385	4001	125 disturbance data words page 2			
:	:	:			
:	:	:			
16523	408B	125 disturbance data words page 140			

Address: 3200 - 3705

Selection of the disturbance record and channel

Word Number	Description	Format	Units and scale	Range
1	No of samples in the mapping	F7		
2	Sample number in pre-time	F7		
3	Sampling rate	F7	per second	
4	Nominal frequency	F7	Hz	0-100
5	Trigger point sample year	F7	year	0 - 199 (as 2000 - 2199)
6	Trigger point sample month, day	F10	month,day	0 - 12, 0 - 31
7	Trigger point sample hour, minute	F11	hour, minute	0 - 23, 0 - 59
8	Trigger point sample millisecond	F7	ms	0 - 59999
9	Phase CT primary current	F7	Ampere	1-10000
10	Earth CT primary current	F7	Ampere	1-10000
11	Phase CT secondary current	F7	Ampere	1-5
12	Earth CT secondary current	F7	Ampere	1-5
13	IL1 channel multiplier	F7	/2048	
14	IL2 channel multiplier	F7	/2048	
15	IL3 channel multiplier	F7	/2048	
16	lo channel multiplier	F7	/8192	

All return 0 if record is empty

PC to calculate first sample date and time by using **trigger point date_time - pre_time** setting.

There are **5 analog and 7 digital** channels in the mapping.

No of samples in the mapping: The total samples in the record for each channel.

Phase primary CT ratio applies to IL1,IL2,IL3 channels. Earth primary CT ratio applies to lo channel.

The secondary CT ratio is always 5.

IL1, IL2, IL3, lo channels: The value is signed 16 bits word equivalent to the ADC value

Frequency channel: Measured frequency value x 100Hz.

Digital input and outputs channel: 16 Bits word

Bit 0: Input 1

Bit 1: Input 2

Bit 2-Bit 7: Unused

Bit 8: Output Relay 1

Bit 9: Output Relay 2

Bit 10: Output Relay 3

Bit 11: Output Relay 4

Bit 12-Bit 14: Unused

Bit 15: Output Relay IRF

IL1, IL2, IL3 channel multiplier: This value divided by 204800 to get channel multiplier.

Io channel multiplier: This value divided by 819200 to get channel multiplier.

Frequency channel multiplier: 0.01

9.3 MODBUS Mapping Format

CODE	DESCRIPTION
F1	2 bytes ASCII character
F2	Unsigned integer – Relay status Bit 0: Eeprom data failure Bit 1: Calibration failure Bit 2: Clock loss Bit 3: Clock error Bit 4: Adc error Bit 11: Back port (RS485) unread fault record Bit 12: Front panel (RS232) unread fault record Bit 13: Front panel/Back port communication Bit 14: Back port unread alarm record Bit 15: Front panel unread alarm record
F3	Unsigned integer – Relay LED status Bit 0 and Bit 1: Trip LED. 1=on, 2=blink Bit 2 and Bit 3: Alarm LED. 1=on, 2=blink Bit 4: LED1 1=on, 0=off Bit 5: LED2 1=on, 0=off Bit 6: LED3 1=on, 0=off Bit 7: LED4 1=on, 0=off
F4	Unsigned integer – Input status Bit 0: Input 1 (0=off, 1=on) Bit 1: Input 2 (0=off, 1=on)
F5	Unsigned integer – Output relay status Bit 0: Output 1 (0=off, 1=on) Bit 1: Output 2 (0=off, 1=on) Bit 2: Output 3 (0=off, 1=on) Bit 3: Output 4 (0=off, 1=on)
F6	Unsigned integer – Miscellaneous A numeric value representation of certain options or functions. Refer to 'range' column of the register for detail.
F7	Unsigned integer A numeric value of certain units Eg. 12 may represent 12% or 12minutes Refer to individual register's 'Units and 'range' for detail
F8	Unsigned long integer – A numeric value of certain units
F9	Unsigned integer – Remote command High byte: 1: Reset alarm/trip (also acknowledge and delete alarm record) 2: Acknowledge alarm/trip 3: Reset display to main page 4: Reset thermal state 5: Reset maximum and average measurement value 6: Remote trip 7: Reset panel password 8: Delete fault record 9: Delete event record 10: Delete alarm record 11: Start Disturbance Record 12: Remote CB close 13: Reset CB Monitor value Low byte: For high byte=3: set to main display page 0-3 For high byte=8,9 and 10: 0=Delete all record, n: delete record n
F10	Unsigned integer High byte: month Low byte: day
F11	Unsigned integer High byte: hour (24 hour format) Low byte: minute
F12	Unsigned integer – Date and time format for relay display only High byte: Date format, 0=DD/MM/YYYY, 1=MM/DD/YYYY Low byte: Time format, 0=12 hour, 1=24 hour
F13	Unsigned integer – Change Group by... 0=Change group by menu, 1=change group change by level of digital input

F14	Unsigned integer A scaled numeric value of certain units Eg. 123 may represent 1.23A or 1.23s Refer to individual resisger's 'Units and Scale' and 'range' for detail
F15	Unsigned integer – Cold Load Pick-up element Bit 0: tl> Bit 1 tl>> Bit 2: tl>>> Bit 3: tlo> Bit 4: tlo>> Bit 5: tlo>>> Bit 6: Thermal overload Bit 7: tl2> Bit 8: tl2>>
F16	Unsigned integer – Input n reset option (For input function set as reset) Bit 0: 0= Not to reset trip/alarm, 1=to reset trip/alarm Bit 1: 0= Not to reset thermal state, 1=to reset thermal state
F17	Unsigned integer – Input n Blocked element (For input function set as blocking) Bit 0: tl> Bit 1 tl>> Bit 2: tl>>> Bit 3: tlo> Bit 4: tlo>> Bit 5: tlo>>> Bit 6: Thermal overload Bit 7: tl2> Bit 8: tl2>>
F18	Unsigned integer – Relay n link element 1 Bit 0: l> Bit 1 l>> Bit 2: l>>> Bit 3: lo> Bit 4: lo>> Bit 5: lo>>> Bit 6: Thermal overload Bit 7: Aux 1 Bit 8: Aux 2 Bit 9: TCS Bit 10: ldemand Bit 11: Remote trip Bit 12: l2> Bit 13: l2>>
F19	Unsigned integer – Relay n link element 2 (Funcion=Start/other) Bit 0: CB close Bit 1: CB Fail Bit 2: Recloser run Bit 3: Recloser block
F20	Unsigned integer – LED n link element 1 Bit 0: Enable Bit 1: l> Bit 2 tl> Bit 3: l>> Bit 4: tl>> Bit 5: l>>> Bit 6: tl>>> Bit 7: lo> Bit 8: tlo> Bit 9: lo>> Bit 10: tlo>> Bit 11: lo>>> Bit 12: tlo>>> Bit 13: tl2> Bit 14: tl2>> Bit 15: Unused
F21	Unsigned integer – LED n link element 2 Bit 0: Input 1 Bit 1: Input 2 Bit 2: Unused Bit 3: Unused Bit 4: Aux 1 Bit 5: Aux 2 Bit 6: Unused Bit 7: Unused Bit 8: Thermal overload alarm Bit 9: Thermal overload trip Bit 10: CB Fail Bit 11: Recloser run Bit 12: Recloser block Bit 13: TCS Alarm Bit 14: Unused Bit 15: Unused
F22	Unsigned integer – Input function 0=None, 1=aux1, 2=aux2, 3=Reset, 4=Blocking, 5=TCS, 6=Grp select, 7=CLPU, 8=Sync clock, 9=CB status, 10=Blk autoreclose, 11 Control close, 12=Start disturbance record Bit 7: 0=Active high, 1=Active low

F23	Unsigned integer – Disturbance record number 0=None 1=6 Records X 3 seconds 2=4 Records X 4 seconds 3=3 Records X 5 seconds 4=2 Records X 7 seconds 5=1 Records X 9 seconds
F24	Unsigned integer – Autoreclose Cycle Allocation Cycles 4 3 2 1 X X X X (bit 0-1: cycle 1, 2-3: cycle 2, 4-5: cycle 3, 6-7 cycle 4) Where X equals to: 0 (00)=no action on autorecloser: definitive trip 1 (01)= trip on pickup-up, followed by reclosing cycle 2 (10)=no trip on pickup
F25	Unsigned integer – Relay status 2 Bit 0: Recloser run Bit 1: Recloser locked Bit 2: Disturbance recorder running
F26	Unsigned integer – Inrush Blocking Element Bit 0: tl> Bit 1 tl>> Bit 2: tl>>> Bit 3: tlo> Bit 4: tlo>> Bit 5: tlo>>> Bit 6: tl2> Bit 7: tl2>>

Revision History

V1.0 May 2017 First version
 V1.1 Jul 2020 Product photo correction. ANSI code to CB monitoring/control and blocking logic added.