

# MIKROSAFE

## SOFTWARE

### INTRODUCTION

Mikrosafe is an integrated software suite, specially designed for monitoring and control of electrical protection and energy consumption in commercial and industrial buildings. It is a powerful data management and reporting tool to help users track and analyze the status and energy performance of electrical installations. Central to this system is its library of user-friendly functions, working seamlessly across various different connected devices.

This software supports Mikro's range of protective relays, digital power meters and power factor regulators that are network enabled. Through this network, data is polled regularly and reports can be generated in the chart form, Excel or PDF format for data analysis. In order to simplify the visualisation of device status and power consumption, Mikrosafe employs the use of single line diagrams and overview diagrams to represent the actual device network architecture. The users may be alerted via email and/or SMS, in the event of trips, connection failures or other alarms.

### FEATURES

- Supports devices that comply with Modbus-RTU and Modbus-TCP standard
- Logs data from devices at specific time interval
- Provides analysis of energy trend in the forms of graphs, charts and reports
- Provides cost estimation based on tariff group or meter group
- Displays overview diagram of device communication and architecture
- Shows actual single line diagram with device location
- Sends SMS and/or email alert when device trips or default
- Provides user and role access control with login password
- Easy setup and user-friendly system
- Offers high performance & reliable communication

### MINIMUM SYSTEM REQUIREMENTS

#### Database & Server Software

- Operating System (OS): Windows 7 SP1 32-bit / 64-bit
- Processor: 2 GigaHertz (GHz)
- RAM: 8 Gigabyte (GB)
- Hard disk space: 500 GB
- Graphics card: Direct X9 or later with WDDM 1.0 driver
- Display: 1024 x 768

#### Client Software

- Operating System (OS): Windows 7 SP1 32-bit / 64-bit
- Processor: 1 GigaHertz (GHz)
- RAM: 4 Gigabyte (GB)
- Hard disk space: 250GB
- Graphics card: DirectX 9 or later with WDDM 1.0 Driver
- Display: 1024 x 768

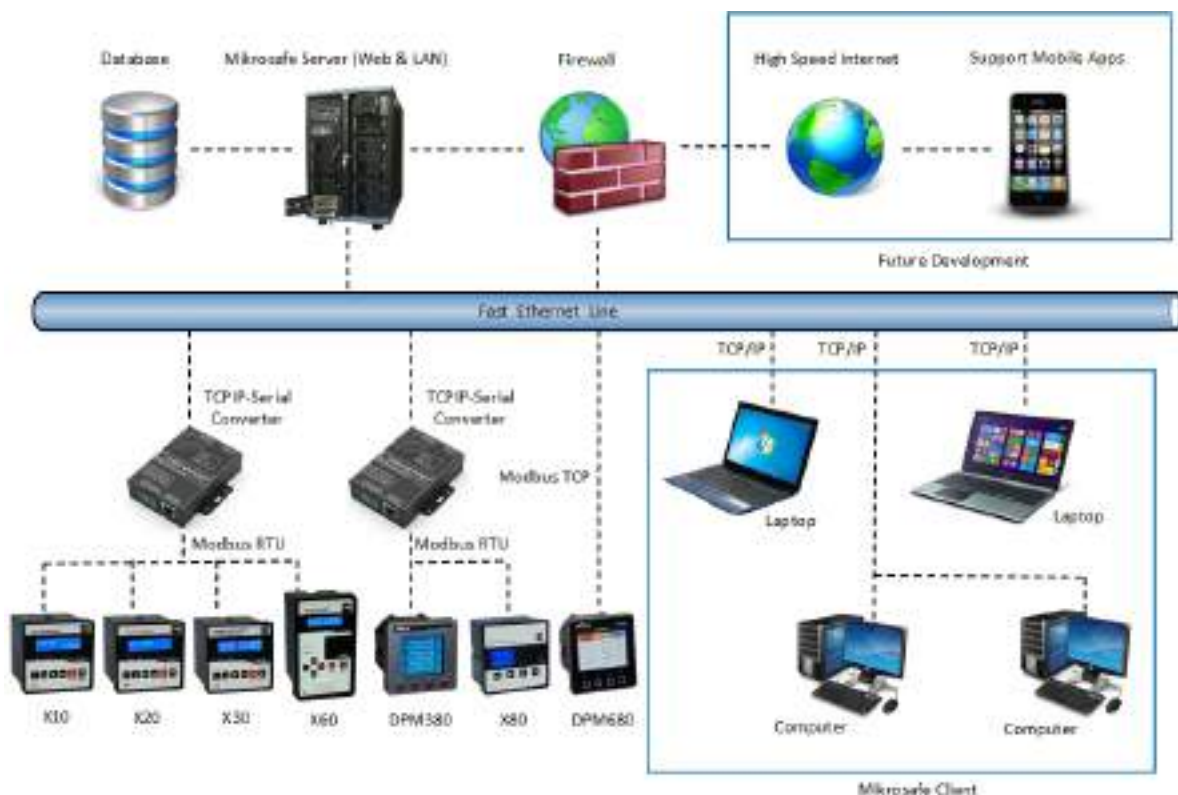

## DEVICES & COMMUNICATION LAYOUT

Pic 1

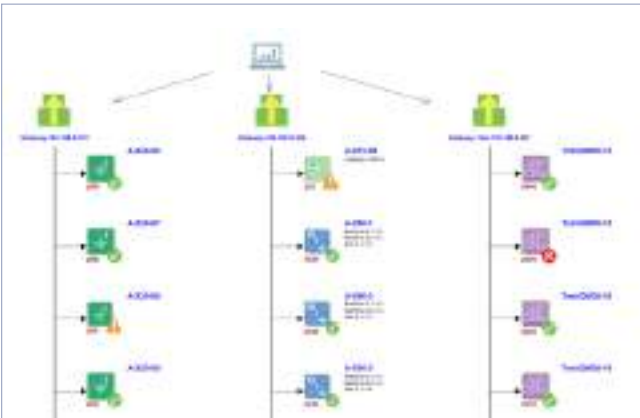

Pic 2



- An overview of physical connection diagram of a building shows clearly how the devices are attached to different communication controllers and device connection status. (Pic 1)
- Each device detail parameters can be seen by double-clicking on the specific device icon. (Pic 2)

## SYSTEM SECURITY

Pic 3



Pic 4



- System is protected with password for security purposes. (Pic 3)
- Different users have different access rights to gain access to different system modules. (Pic 4)

## NOTIFICATION ALERT

Pic 5



Pic 6

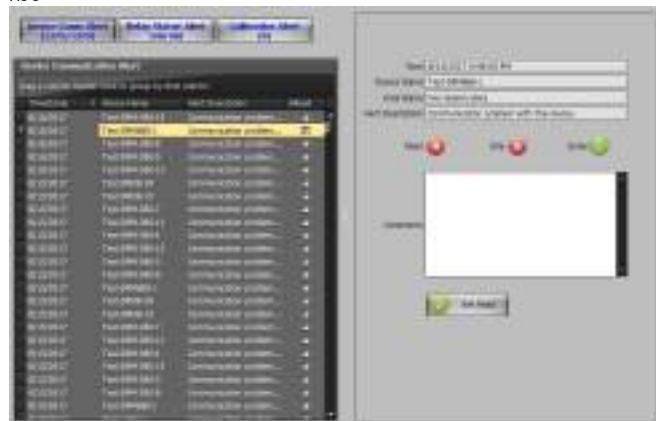

- Automated sending of emails and SMS alert in the event of operational failure or faults. (Pic 5)
- All alerts will be prompted and remain in the system for attention until the issue is solved and kept as history. (Pic 6)

## DIAGRAM VIEW

Pic 7

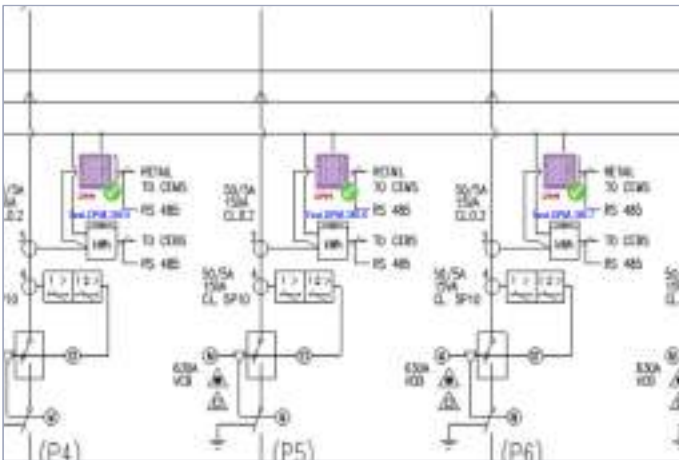

Pic 8



- User can upload the original building diagram with the designated devices allocation. This provide a clearer picture for analysis purpose. (Pic 7)
- User can double-click on the specific device icon from the diagram to gain access to more details. (Pic 8)

## ENERGY MANAGEMENT & MONITORING

Pic 9

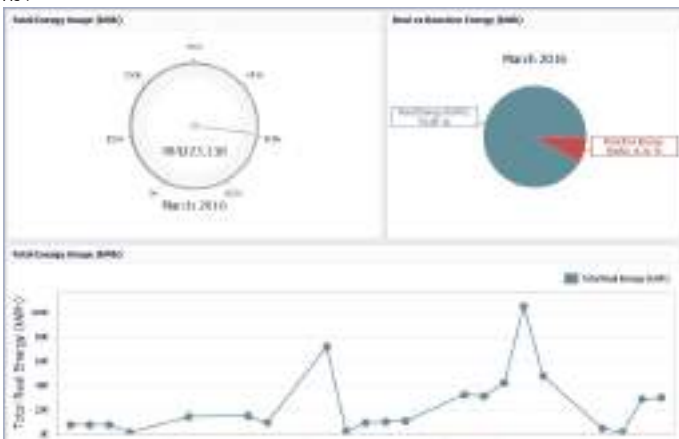

Pic 10

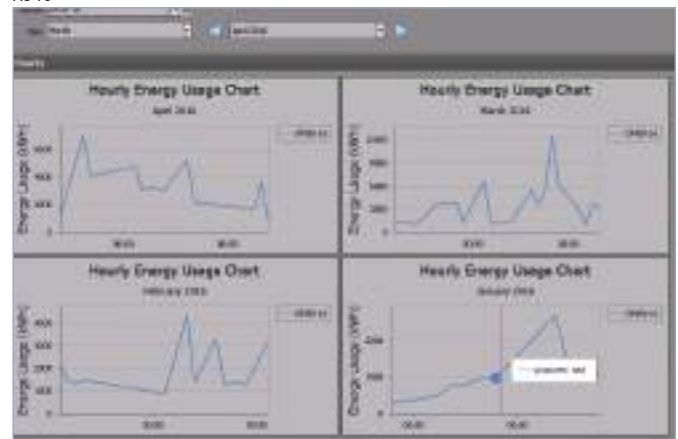

- Energy trend analysis chart and graph can be generated based on previous recorded energy data at specific time interval. (Pic 9)
- By having daily/monthly basis energy usage comparison chart, energy efficiency consumption trends can be seen easily and cost can be controlled in an efficient manner and allow to move towards a green building future. (Pic 10)

## REPORTING

Pic 11

Pic 12

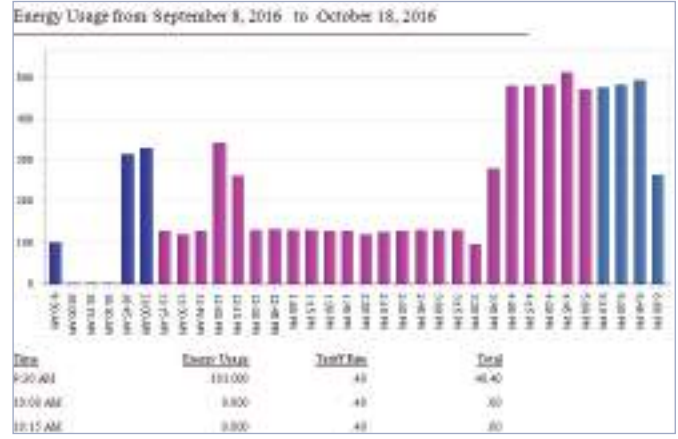

- Analyzes devices' parameters individually between a specific time interval is available. Data can be sorted by ascending or descending order on any parameters and export to Excel spreadsheet for printing is also possible. (Pic 11)
- Energy usage based on tariff settings is provided for cost estimation reporting. (Pic 12)