

# RX1000 Combined Overcurrent and Earth-fault Relay User Guide

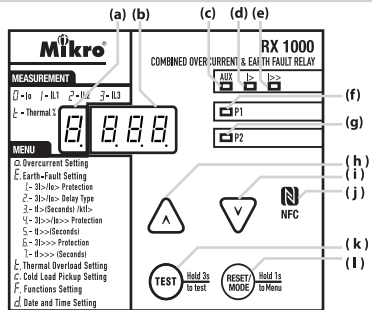

- (a) Function indication
- (b) Data indication
- (c) Auxiliary power supply indicator
- (d) Low-set start/trip status indicator
- (e) High-set start/trip status indicator
- (f) Programmable LED1 indicator
- (g) Programmable LED2 indicator
- (h) Up button
- (i) Down button
- (j) NFC detection area
- (k) Test button
- (l) Reset/Mode button

## Features

- Three-phase, three stages setting for phase overcurrent
- Two stages setting for earth fault
- IDMT and definite time
- Thermal overload protection
- Cold load pickup protection
- Circuit breaker failure protection
- Selectable fundamental or true RMS
- Selectable 50 or 60 Hz frequency
- 2 Programmable LED
- Programmable Output Contacts
- 30 Fault, 30 pickup and 120 event records date & time stamp
- Build in NFC for read and set parameters through mobile app
- Complies with IEC 60255 standard
- ANSI code: 50G, 50P, 50N, 51G, 51P, 51N, CLP, 50BF, 49RMS

## Case Dimensions

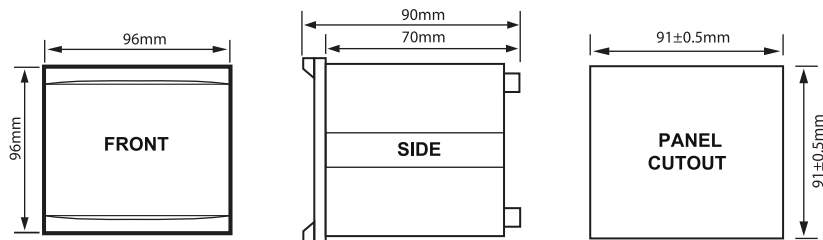

## IDMT Curve

Normal Inverse 3/10

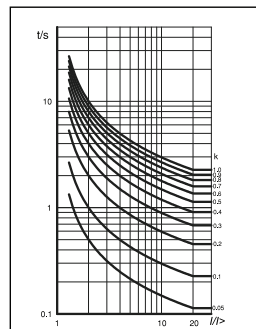

Normal Inverse 1.3/10

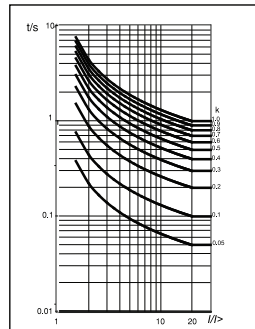

Very Inverse

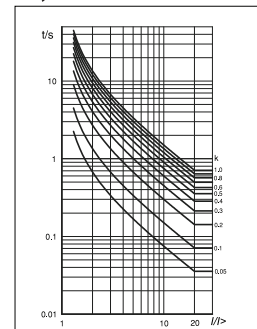

Long-time Inverse

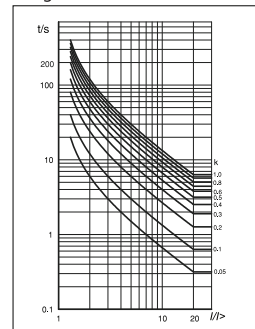

Extremely Inverse

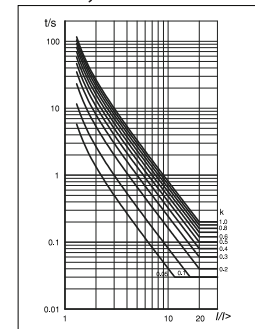

## Typical Application Diagram

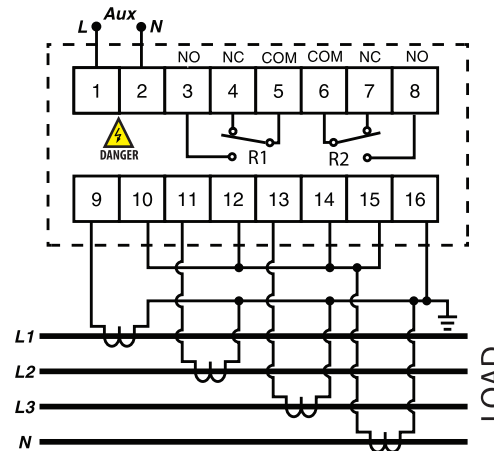

## NFC Communication



Relay provides NFC communication convenient for user to read parameter values or to change setting through Android phone with NFC feature. The Mikro RX app can be downloaded in the mobile with one of following Methods:

**{Make sure phone NFC function is turned on}**

- Scan the QR code or align the mobile phone NFC antenna on the NFC logo at relay front panel. This will take you directly to App store.



## Technical Data

### Ratings

Rate Current In.....	5A
Frequency.....	50 or 60Hz
Burden.....	<0.3VA at In
Thermal Withstand.....	4 x In Continuous

### Auxiliary Supply

Supply Voltage.....	198 ~ 265VAC
Supply Frequency.....	50 or 60Hz
VA Rating.....	3VA max

### Accuracy

Protection Thresholds.....	±3% with a minimum 20mA
Time Delay.....	±3% with a minimum 40ms

### Setting Ranges

<b>(i) Overcurrent Setting</b>	
Low-set Setting 3I>.....	0.5A - 12.5A(10% - 250%)
Low-set time Multiplier ktI>.....	0.01 - 1.00
Low-set Definite Time tI>.....	0.03 - 100s
Delay Type.....	DT, NI3/10, NI1.3/10, VI, LI, EI
High-set Setting 3I>>.....	OFF/0.5 - 100A (10% - 2000%)
High-set Definite Time tI>>.....	0.03 - 100s
Highest-set Setting 3I>>>.....	OFF/0.5 - 100A (10% - 2000%)
Highest-set Definite Time tI>>>.....	0.03 - 100s

### (ii) Earth-fault Setting

Low-set Setting Io>.....	0.1A - 10.0A(2% - 200%)
Low-set time Multiplier ktIo>.....	0.01 - 1.00
Low-set Definite Time tIo>.....	0.03 - 100s
Delay Type.....	DT, NI3/10, NI1.3/10, VI, LI, EI
High-set Setting Io>>.....	OFF/0.1 - 50A (2% - 1000%)
High-set Definite Time tIo>>.....	0.03 - 100s

### (iii) Thermal Overload Setting

Low-set Setting IO>.....	OFF/0.5A - 10.0A(10% - 200%)
Low-set Tθ.....	1 to 200 minutes
Low-set time Multiplier ktIθ>.....	1.00 - 1.50
θ Trip.....	50 to 200%
θ Alarm.....	50 to 200%

## Output Contacts

Rated Voltage.....	250VAC
Continuous Carry.....	5A(Cosφ = 1.0)
Expected Electrical Life.....	10 <sup>5</sup> operations
Expected Mechanical Life.....	5 x 10 <sup>6</sup> operations

## Environmental Conditions

Temperature.....	-10°C to 55°C
Humidity.....	5% to 95% non-condensing

## Mechanical

Mounting.....	Panel mounting
Dimension (mm) .....	96(w) x 96(h) x 90(d)
Enclosure Protection.....	IP54 at the panel IP20 at the body
Approximate Weight.....	0.8kg

# System Operation

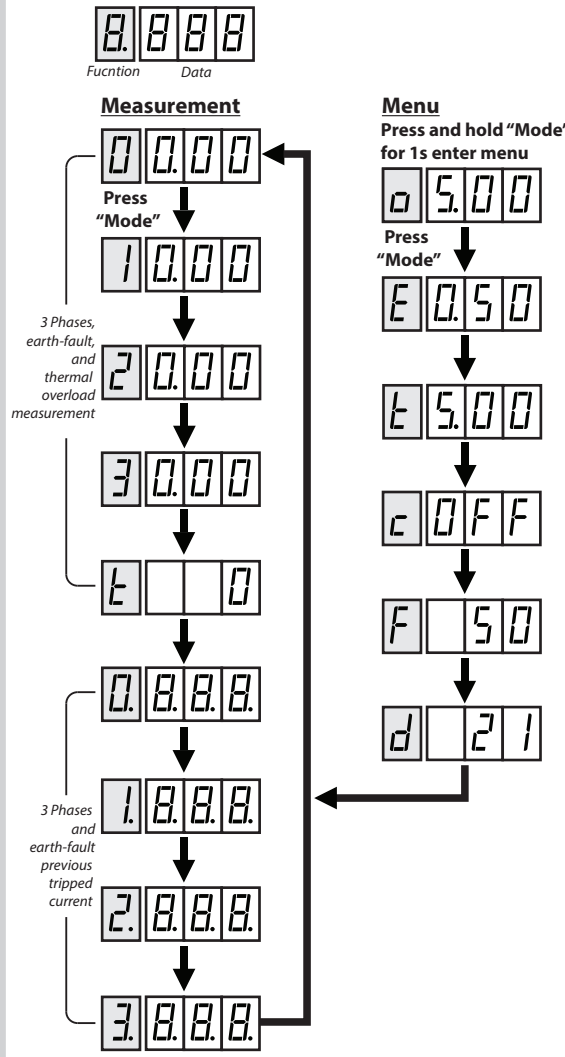

## Parameter Settings

0	Overcurrent Setting
1	3I> Protection (A) [DEF=5.00]
2	3I> Delay type [DEF=NI]
3	tl> (Seconds)/ktl> [DEF=0.1]
4	3I>> Protection (A) [DEF=50.0]
5	tl>> (Seconds) [DEF=0.05]
6	3I>>> Protection (A) [DEF=100]
7	tl>>> (Seconds) [DEF=0.03]

E	Earth-Fault Setting
1	lo> Protection (A) [DEF=0.50]
2	lo> Delay type [DEF=NI]
3	tlo> (Seconds)/ktlo> [DEF=0.10]
4	lo>> Protection (A) [DEF=10.0]
5	tlo>> (Seconds) [DEF=0.05]

t	Thermal Overload Setting
1	Iθ> Protection (A) [DEF=OFF]
2	tIθ> (Minutes) [DEF=10]
3	ktIθ> [DEF=1.10]
4	θ Trip (%) [DEF=100]
5	θ Alarm (%) [DEF=100]

c	Cold Load Setting
1	3I> [DEF=OFF]
2	3I>> [DEF=OFF]
3	3I>>> [DEF=OFF]
4	lo> [DEF=OFF]
5	lo>> [DEF=OFF]
6	Iθ> [DEF=OFF]

d	Date and Time Setting
1	Year
2	Month
3	Day
4	Hour
5	Minute
6	Second

[DEF=Default setting]

F	Functions Setting
1	Frequency [50Hz/60Hz] [DEF=50Hz]
2	Measurement display [Fn=Fundamental, RnS=RMS] [DEF=Fn]
3	Programmable LED 1 [Refer figure 1] [DEF=20h]
4	Programmable LED 2 [Refer figure 1] [DEF=00h]
5	Output R1 reset type [n-A= Manual, AUT= Auto] [DEF=n-A]
6	Output R2 reset type [n-A= Manual, AUT= Auto] [DEF=AUT]
7	Output R2 function [DEF=IrF] [Str= Start, trp= Trip, cbF=Circuit breaker failure, IrF= Internal relay failure]  *IRF contact function Relay healthy : R2 energized Relay fault : R2 de-energized
8	Output R1 link element [Refer figure 1] [DEF=3Fh]
9	Output R2 link element [Refer figure 1] [DEF=3Fh]
A	CBFP Delay [0.05s - 10.0s] [DEF=0.10]
b	NFC remote set [Yes/No] [DEF=No]

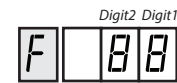

HEX	Digit2		Digit1			
	Iθ>	lo>>	lo>	3I>>>	3I>>	3I>
00	0	0	0	0	0	0
01	0	0	0	0	0	1
02	0	0	0	0	1	0
03	0	0	0	0	1	1
04	0	0	0	1	0	0
05	0	0	0	1	0	1
06	0	0	0	1	1	0
07	0	0	0	1	1	1
08	0	0	1	0	0	0
09	0	0	1	0	0	1

Figure 1: Link element in Hexadecimal value

0= Off, 1= On

3A	1	1	1	0	1	0
3B	1	1	1	0	1	1
3C	1	1	1	1	0	0
3D	1	1	1	1	0	1
3E	1	1	1	1	1	0
3F	1	1	1	1	1	1

User's setting hexadecimal value	Digit2		Digit1			
	Iθ>	lo>>	lo>	3I>>>	3I>>	3I>

\* Not applicable when output R2 function set as cbF or IrF

## Push Button Operation

Trip Test	Press and hold "TEST" button for 3.5 seconds
Trip Reset	Press "RESET" button
Scroll Display	Press "MODE" button
Enter Menu Mode	Press and hold "MODE" button for 1second
Set/Save Setting	Press "UP" and "DOWN" button simultaneously
Adjust Setting	Press "UP" or "DOWN" button
Auto Scroll Reading	Press and hold "UP" and "DOWN" button simultaneously for 2 seconds on Measurement mode
Clear Thermal %	Press and hold "UP" and "DOWN" button simultaneously for 1.5 seconds on Thermal page
Display Off Mode	Press "RESET" button for 10 seconds to toggle display off mode. The display will switch off after 6 minutes if no key is pressed.

## LED Indicator

AUX	LED			Status
	I>	I>>	P1/P2	
0	0	0	0	No Auxiliary power supply
1	0	0	0	Normal condition, no tripping
1	1	0	X	Low-set pickup
1	0	1	X	High-set pickup
1	B	0	X	Low-set tripped
1	X	B	X	High-set tripped
1	X	X	1	Link element pickup
1	X	X	B	Link element tripped

1 = ON    0 = OFF    B = Blinking    X = don't care

## Thermal Overload Curve

